

# Measuring & monitoring systems

## Solutions for smart machines, factories & grids

Let's connect.

Version 2021



**Weidmüller** 

## Our Orange Selection

### Quick and easy planning

As a planning engineer, do you want to select products easily and receive them quickly? From a partner you can rely on? Then plan with the Orange Selection from Weidmüller in the future. The Orange Selection items are always available, carefully selected and the portfolio consists of more than 1,500 items to fully cover your standard needs.

If your order is placed before 3:00 pm, we guarantee that your order will be on its way the very next working day.

For even more efficient planning and production processes, we will of course provide all articles in digital form. CAD, ETIM and eClass data are available in our online product catalogue **catalogue.weidmueller.com**

We have summarised all the advantages of the Orange Selection on our website.

**Check it out: [www.weidmueller.com/orange-selection](http://www.weidmueller.com/orange-selection)**

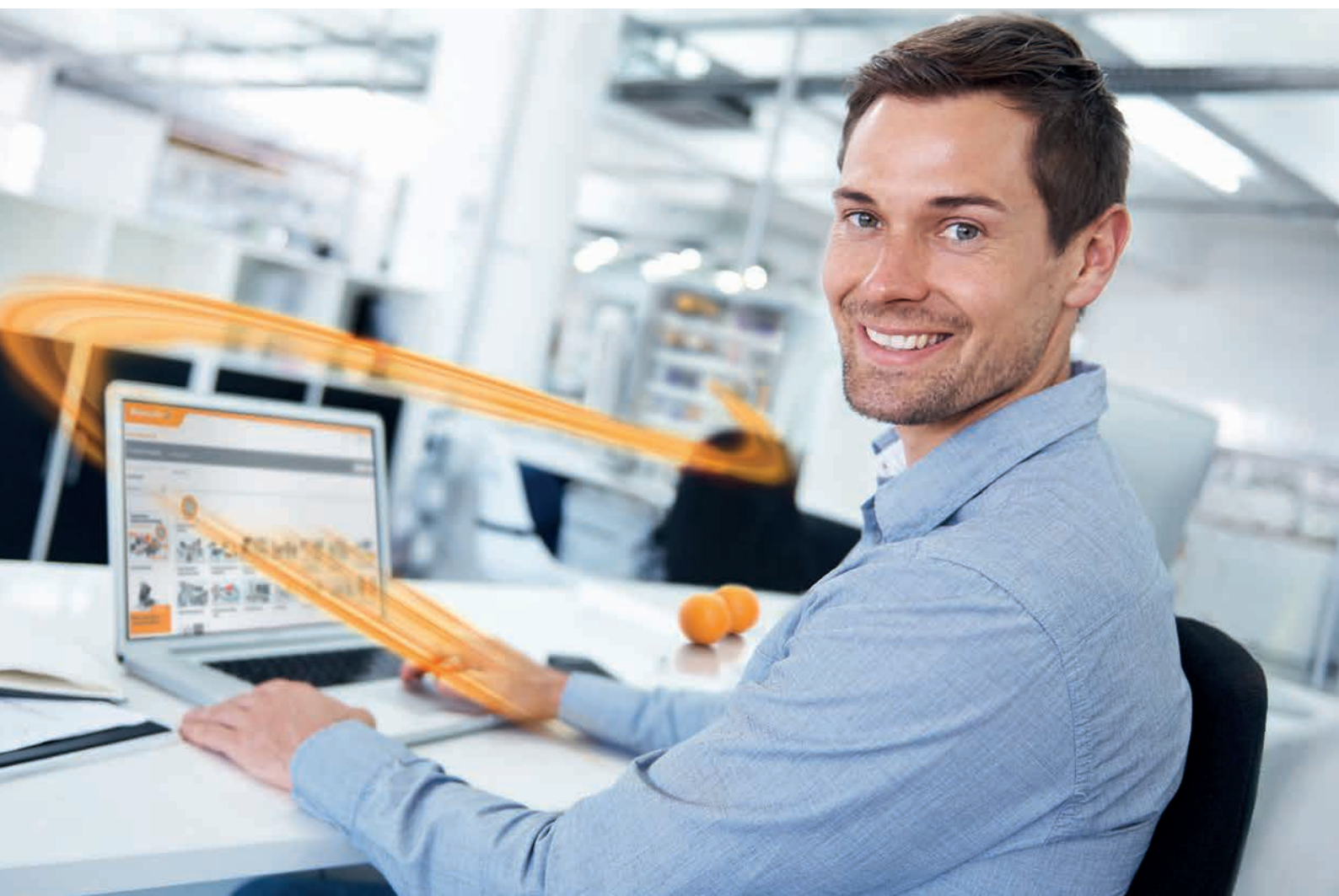

# Measuring & monitoring systems

## Solutions for smart machines, factories & grids

Measuring & monitoring systems  
Solutions for smart machines,  
factories & grids

Hardware

Software

Service

Contents

**A**

**B**

**C**

**Appendix**

**Index**

Search according to type or order number,  
worldwide activities

**X**



# Hardware

<b>Hardware</b>	Industrial IoT with measuring and monitoring systems	A.2
	Total Energy Monitoring	A.4
	Power Quality Monitoring	A.16
	Residual Current Monitoring	A.18
	Overview: Energy measurement & analysis devices	A.20
	Energy Meter	A.22
	Energy analyser	A.32
	Energy & Data Logger	A.38
	u-sense vibration	A.40
	u-sense energy drives	A.42
	IoT-terminal	A.44
	Current transformer	A.48
	Retrofitting energy management solutions	A.68
	Peripherie Energy Management	A.76
	Automation kit	A.78
	Industrial Ethernet	A.102

# Industrial IoT with measuring and monitoring systems

The way to Industrial IoT does not have to be complicated. No matter whether access to valuable data is required or if new, data-related services are to be generated, Weidmüller offers components and services for easy access to the Industrial IoT.

With the comprehensive, future-oriented and coordinated IoT-capable portfolio, the path to the Industrial IoT can be a successful one – „from data to value“ – both for greenfield and brownfield applications. The solutions from the areas of data acquisition, data pre-processing and data communication form the infrastructure on which the logical linking and evaluation of the collected information – the data analysis – is based.

One thing is clear: digitalisation is not an end in itself. The added value is exploited in the specific use case, whether this is the collection of process data, energy management, ensuring availability with condition monitoring or deploying service technicians more efficiently thanks to remote maintenance. And last but not least, new business models can be created by using artificial intelligence without having to be a data scientist – Weidmüller is designing the digital transformation both with and for the user: it's simple and efficient.

## Industrial Internet of Things (IIoT) is increasingly permeating the production

- ▶ **Interconnection of 15 billion communication-capable machines**
- ▶ **Components of the advancing automation and digitalization process**
- ▶ **Predictive Maintenance and Energy monitoring**

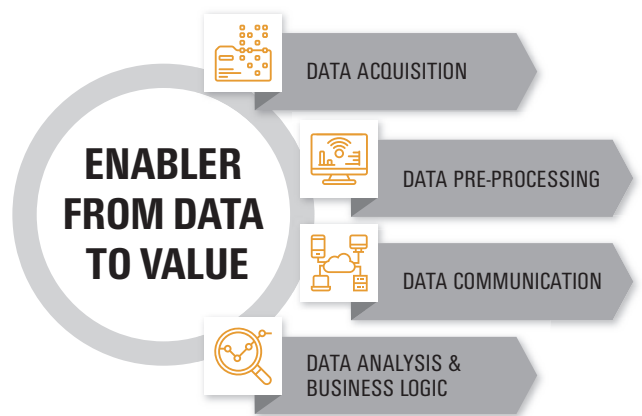

# Industrial IoT, Data Acquisition & Energy Management Product Portfolio

## Holistic Offering for Industrial Data Acquisition

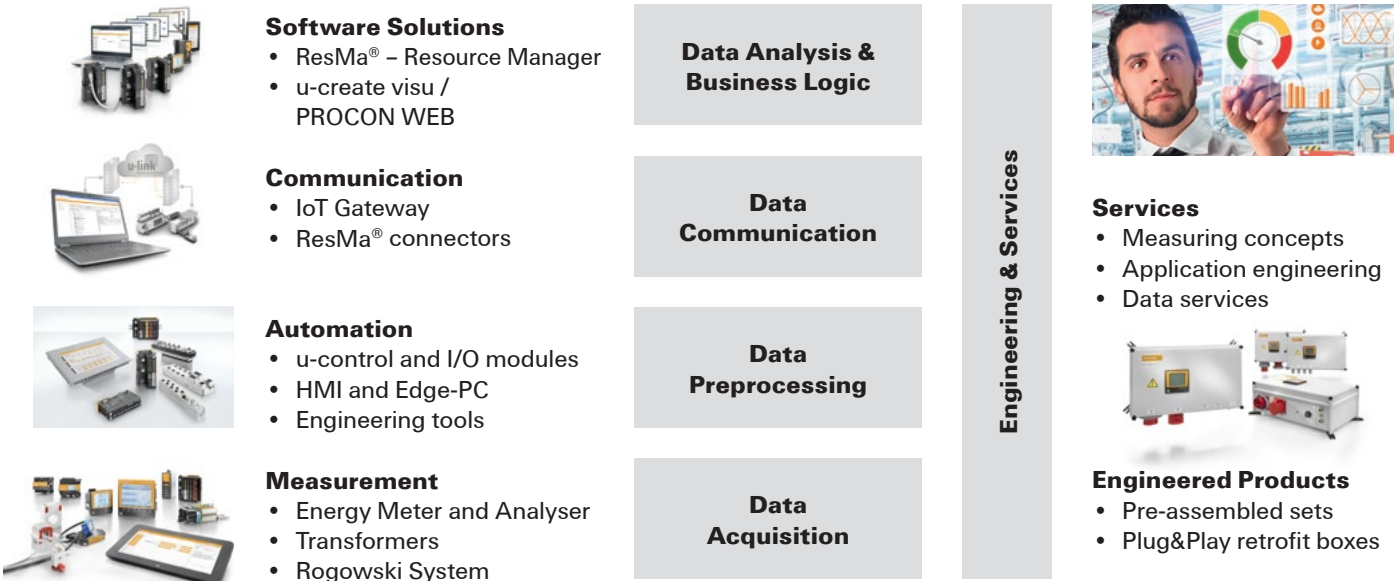

## Target Applications

Industrial IoT with measuring and monitoring systems	<b>Energy Monitoring &amp; Management</b>	<ul style="list-style-type: none"> <li>• Manufacturing companies that want to improve energy efficiency (ISO 50001 – EN 16247-1)</li> <li>• Customers with trouble in grid quality as well as electromagnetic compatibility</li> <li>• Improvement of plant availability by measuring residual currents</li> </ul>
	<b>Factory Data Acquisition</b>	<ul style="list-style-type: none"> <li>• Companies that want to improve and monitor their production (processes) as well as their manufacturing environment</li> <li>• Customers with need of condition monitoring or live visualization of production</li> <li>• Automation and integration of different silo applications from different suppliers</li> </ul>
	<b>Machine Data Acquisition</b>	<ul style="list-style-type: none"> <li>• Machine builders that want to monitor their machines in the field</li> <li>• Machine integrators willing to improve their maintenance contract and offer new services for their end customers</li> <li>• Data acquisition of different machine types with various PLCs</li> </ul>

# Maximum energy efficiency and plant availability

## Tap new potential with Total Energy Monitoring

Total Energy Monitoring is Weidmüller's holistic modular system for measuring and monitoring the power supply network. Entire manufacturing energy networks can be continuously monitored and analysed in detail – even remotely.

### Effectively maximise energy efficiency and plant availability

Climate change and dwindling resources are global megatrends that are increasingly influencing corporate action. It also holds true that if you reduce energy costs, you increase profitability. In addition, high plant availability is playing an increasingly prominent role for ensuring efficient production processes. These factors require a specific package of measurements that is individually tailored for each company.

With Total Energy Monitoring, Weidmüller has developed an equally comprehensive and flexible product range for individual solutions: hardware, software and consultancy services are tailored to fulfil the purpose of the customer-specific Energy Management solution. The concept supports also the international ISO 50001 directive and makes projects easier to plan and realise.

### Seamless portfolio for plants of all sizes

Achieve full transparency of your manufacturing energy consumption. Manufacturing energy networks can be fully monitored and analysed from the interconnection point and sub-distribution all the way down to the individual machine modules. You gain a better understanding of the process and more control over your energy costs and machine processes.

The Weidmüller solution supports this optimisation process with software and hardware components which can be used flexibly. They are highly compatible, even when used in collaboration with already installed energy measurement systems and can be easily adjusted to individual application requirements. In short, you can always rely on a seamless production portfolio with optimum quality for all levels of production. The improved availability and efficiency of your entire plant will quickly become noticeable.



### Expertise and awards

Weidmüller has a long tradition of energy efficiency. During the time between receiving our first award, the ASU Environmental Prize in 1990, and the German Innovation Award in 2018, we have enjoyed decades of pioneering work and development. An outstanding example of accurate energy monitoring is our production location in Detmold, which was awarded the title of a climate protection company in 2013. Implemented with our proprietary components, the hardware in combination with the specialised software provides the best prerequisites for successful energy monitoring.

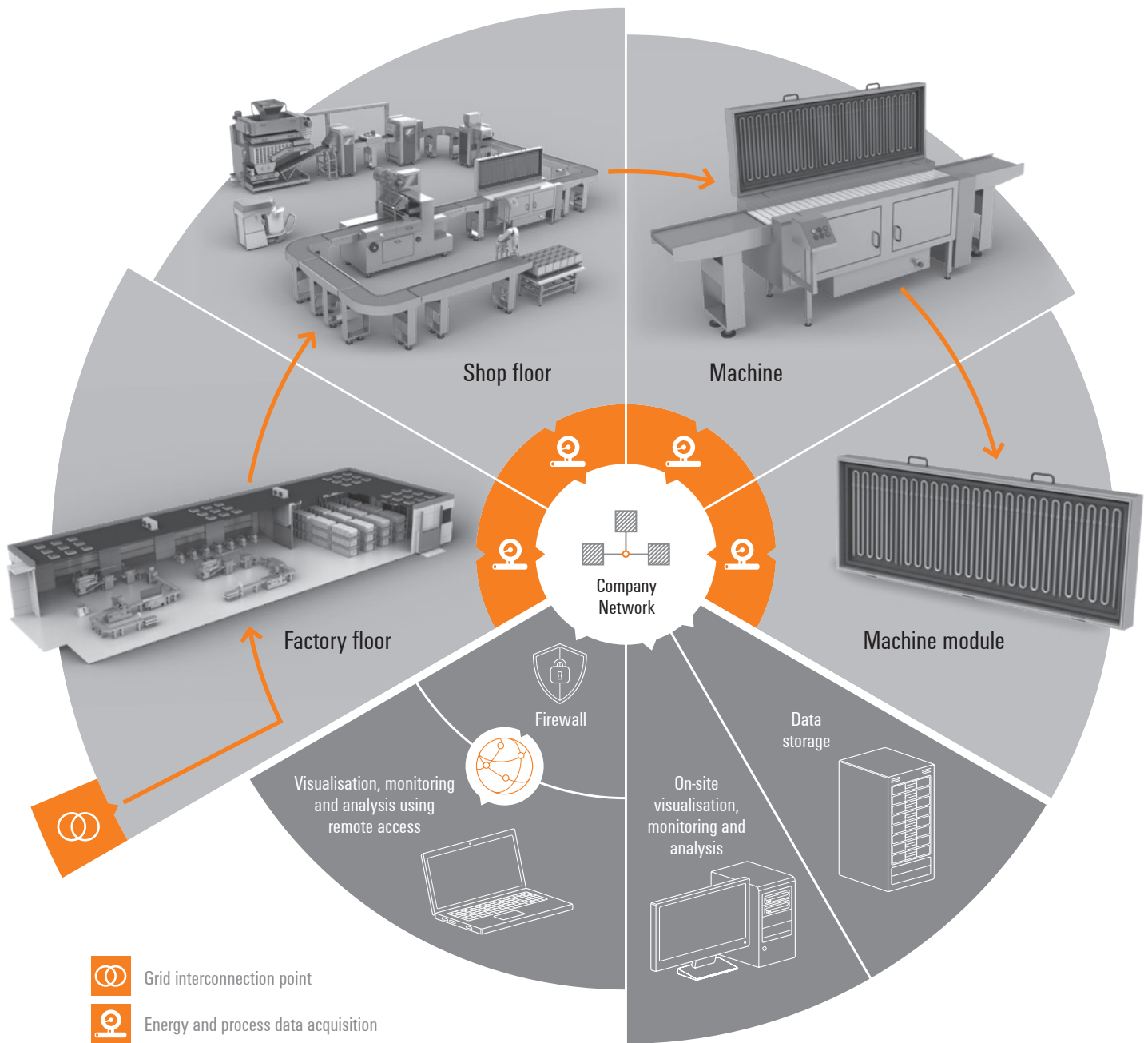

**Total Energy Monitoring for all four levels of production**

The Total Energy Monitoring concept ensures consistency from interconnection points in the factory, down the production lines and individual machines and into the heart of the machine processes.

The solution allows you to monitor current and energy measurement data as well as other process data relevant for energy monitoring within your entire concept, such as

flow rates, temperatures or pressures. Transferring the measurement data to a central data server allows for immediate access and prompt evaluation using the u-create ResMa® software.

In addition the flexible remote maintenance solution u-link is available which provides the ability to communicate from remote into the machine module level.

# Implement your own individual Energy Management system

## With our integrated expertise from a single source

Energy Management is a triad of recording all relevant energy consumption data, analysing the information obtained, and comprehensive consulting on possible saving potential. We at Weidmüller see the development of an Energy Management system as a holistic task which combines expert advice with intelligent hardware and software solutions to form a strong unit which is modular in design and therefore tailored to your requirements.

### Hardware components

Extraction of exact measurement data for analysis

#### Integrated planning of the approach

Use our comprehensive hardware portfolio of selected „Total Energy Monitoring“ components for energy consumption measurement and monitoring, integrated analysis of the quality of electrical supply networks and for efficient, convenient provision of measurement data.

#### Selection of suitable products, solutions and functions

- u-remote measurement module
- Energy meters
- Energy analyser
- Energy loggers
- Measurement converter
- disconnecter terminals
- Current transformers
- Power supply solutions
- Connection technology
- u-mation toolbox
- Industrial communication infrastructure
- Customer-specific Plug&Play solutions
- Rogowski coils

#### Modular adaptation to your requirements

##### Simple, cost-effective integration into existing systems

Broad range of universal-fit connection solutions to connect existing hardware

##### Use of high-quality, tried and tested standard components

Well proven components that are tailored to each other from the Weidmüller standard range

##### Option of implementing tailored solutions

Customer-specific assembly and construction of components to meet individual requirements



**Software and controlling**

Determination of relevant indices for planning

**Advice and design**

Capable support through to certification

The software modules of the Weidmüller Energy Suite meet your requirements, from the sensor level to the cloud. Parameterise our field devices using ecoExplorer go, digitise the data using the u-create data hub, conduct standardised analyses using the u-create ResMa® or forecast load peaks with the u-create energetics System. The perfect interaction between Weidmüller field devices and the components of the Weidmüller Energy Suite ensures the greatest possible predictability, even for complex requirements.

Starting with a specific demand analysis, we work on proposals for the measurement and visualisation of the energy data to be recorded and handle the detailed planning for the implementation of Energy Management. Together with you, we work out energy efficiency measures and, if desired, support the implementation process right through to the certification of your company in accordance with ISO 50001 and beyond.

- Recording process and energy data
- Registering energy and raw materials prices
- Forecasting costly load peaks
- Cost centre analyses
- Long-term data archiving
- Database interfaces for MES/SCADA systems

- Energy auditing and measuring point concepts
- Energy efficiency analyses and simulations
- Energy monitoring and controlling
- Tax and expenses optimisation
- Staff training sessions and seminars
- ISO 50001 Energy Management
- DIN EN 16247-1 energy audit
- Load profile analyses
- Monitoring grid and power quality

**Compact – IPC-based entry-level solution**

Record, automate and bundle measurement data on a central basis. Create transparency about energy media and draw up initial reports.

**Server – Extensive scalable**

Strong integration into your own infrastructure for extensive data collection. Ideal for cross-site Energy Management.

**Cloud – Energy Management on a rental basis**

Use intelligent data collectors in the field to evaluate your energy data easily, conveniently and safely in the cloud.

**Optimisation by your own specialists**

We ensure transparency - You implement the knowledge gained appropriately with your employees.

**Support with achieving short-term savings**

Based on the data gathered, we work with you to develop effective solutions for basic and peak load reduction.

**Long-term support for lasting optimisation**

You are given long-term support with the continuous optimisation of your energy use.

# Energy Management in practice

## Insights into Weidmüller's „transparent factory“

Weidmüller has a long tradition of handling energy and resources responsibly. One perfect example for the practical implementation of our collective know-how and the effects which can be achieved is our production hall at the Detmold site. We can use specific examples to show interested customers how well modern Energy Management works in practice.

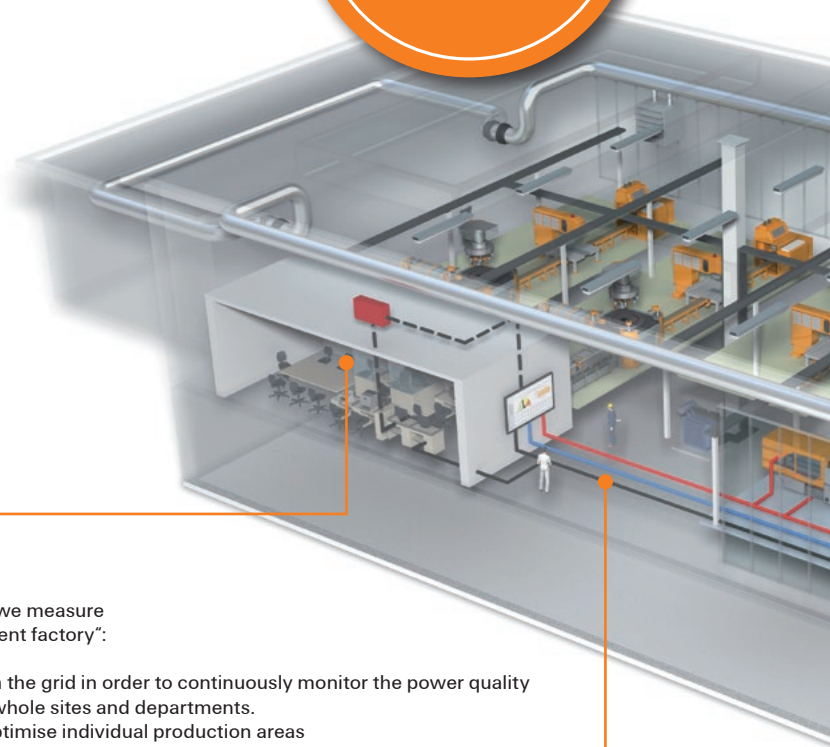

### Anchoring Energy Management

All employees are given comprehensive training to increase awareness of conserving energy as a resource. Projects to optimise procurement, increase production efficiency, for new buildings and renovation and handling Energy Management tools are carried out in order to reduce energy consumption even further in future.

### Transparency at every level

Depending on the degree of detail required, we measure Energy flows at all five levels in our „transparent factory“:

- Measurement at the point of interface with the grid in order to continuously monitor the power quality
- Measurement at factory level to optimise whole sites and departments.
- Measurement at production line level to optimise individual production areas
- Measurement at machine level to optimise complex process structures
- Measurement at machine module level to optimise individual machine and plant elements

#### Production area



#### Employees in production



#### Annual CO<sub>2</sub> saving

approx. 1.665 t CO<sub>2</sub>

**Needs-based lighting control**

Reduction of basic lighting helps reduce the basic load. Where more light is required, lighting positioned as required provides optimum adapted lighting. The use of efficient control and lighting systems minimises the energy required further still.

**Systematic minimisation of energy losses**

Load-optimised main consumers guarantee optimum energy use with reduced energy peaks. Systems in standby mode are switched off. This saves energy and helps reduce the basic and peak loads. Transformers are installed at the performance hotspots near the main consumers and fitted with efficient technology to avoid conversion losses. Distribution routes in the low voltage sector which are as short as possible also minimise conductor losses.

**Visit our „transparent factory“ with its multi award-winning energy efficiency measures.**

Arrange an appointment with your sales engineer



**Efficient use of compressed air**

Cascaded compressors are intelligently controlled to ensure the network pressure built up is only what is required. Cables are carefully routed, sealed and constantly checked to minimise cable losses. Employees are made aware of the most efficient use of compressed air to reduce the consumption of compressed air further still.

**Efficient heating and cooling**

The excess heat generated by processes is transferred to the heating system. The heat extraction reduces the burden on the machine cooling system. A free-cooler uses the ambient air for cooling with minimum use of electrical power and even takes over all cooling work in winter. The core processor heat created when generating compressed air is also used and fed back into the heating system.

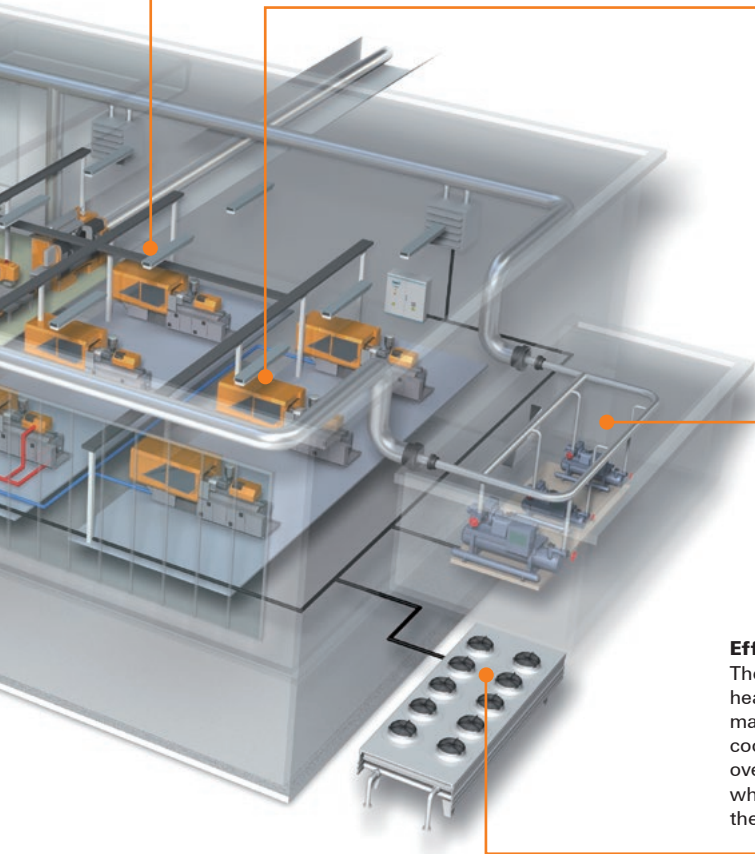

## Energy and process data acquisition - step by step

More than energy management: ResMa<sup>®</sup> helps to optimize right up to the process level

Good energy management is the result of the interaction between people and technology. Both sides contribute their expertise. This report outlines what to expect from a good system.



It is more important than ever to reduce a company's energy consumption and to increase efficiency with targeted measures. High energy costs and legal regulations require a targeted and structured approach.

According to company information, Weidmüller GTI's ResMa<sup>®</sup> energy management system helps to record and monitor energy flows and process data as well as evaluate and optimise efficiency. „The generation of meaningful EnPIs (KPIs) including production parameters and their monitoring using energy monitoring is the basis for the reduction of daily monitoring expenses“, explains Weidmüller GTI in a press release.

### Consumption overview

The consumption overview and the resulting energy balancing means that approaches can quickly be determined with the aim of expanding the measuring equipment or introducing concrete saving potential. These approaches are documented in the PDCA cycle and then reviewed.

Interactively adaptable charts help provide a detailed analysis; they allow for the optimal representation of correlations for every situation and can be saved for further editing, including by other colleagues. Customable reports balance energy and KPIs from production in a clearly arranged layout.

### Energy management according to ISO 50001

With the ResMa<sup>®</sup> energy management system, Weidmüller GTI Software is offering a comprehensive software solution for energy management according to ISO 50001, The energy and resource manager allows manufacturing companies and other organisations to systematically and continually increase energy efficiency. The system supports all tasks for efficient and active energy management, refers to factors that can be influenced by the company and can be adapted to individual requirements. At the same time, the solution also includes the necessary support for the integration into existing automation technology, control technology or

building automation and for the connection of the company's IT systems. Customer-specific requirements regarding energy planning, peak-load optimisation or on-demand control can be tailored to the customer's needs by means of customised support.

### User in Kronach

Horst Scholz GmbH in Kronach, Franconia, uses ResMa® for energy management in multiple production and administration buildings; the company specialises in the production of high-precision plastic parts for microtechnology and medical technology. Because some buildings already had energy meters, these were to be integrated into the system. Additional energy meters were connected via Modbus TCP based on the good network infrastructure that was already in place.

### Modbus-TCP

The first step involved the company independently adding all of the meters in its first building to the system. Convinced by the simple connection, the company then equipped the newly constructed building with Modbus TCP-capable meters as well. In order to prevent data loss in the event of a

network failure, ResMa®-Connect industrial PCs were used, which are set up close to the measurement technology and which cache the data.

„ResMa® allowed us to carry out the step-by-step development of our EnMS on our own and opened up potential for integrating extensive information from production“, says Wolfgang Fehn, the management representative for quality and environment at Horst Scholz GmbH.

### Process data recording

The third expansion stage has now been implemented, involving the recording of process data from automation technology. For this purpose, Scholz uses three ResMa® connectors and a direct network connection to the most important machines. This makes it possible to use extensive data from the production process directly for KPI development and the performance of analyses within ResMa®.



## How can large-scale electricity grids be modernised successfully? Support from Weidmüller with key component

If, for example, the electricity grids of a six-digit square kilometre area need to be renewed, this amounts to a costly infrastructure project. If the substations also need to be modernised and digitalised as part of a sub-project, the control cabinets need to be renewed in their entirety. Experts from Weidmüller support control cabinet builders who specialise in automation in power distribution.



Any control cabinet manufacturer that needs to find a partner whose components comply with regional and national approval regulations for monitoring power quality will find what they are looking for with Weidmüller. With its key product Energy Analyser D550, a multifunctional measuring device for monitoring voltage quality in accordance with IEC 61000-2-4 and EN 50160, among other things, Weidmüller even satisfies the most demanding requirements. Another advantage is the fact that as a major manufacturer, Weidmüller is geared towards being able to supply large quantities at short notice.

### Cooperation from the very beginning

When replacing the control cabinets, it is crucial to ensure universal monitoring of the transformers. This is where the Energy Analyser can really show off its strengths. It measures various parameters of the network quality such as short-term interruptions, transients, starting currents, voltage fluctuations or harmonics caused by contamination. It transfers this data via a Modbus interface for evaluation. This provides the company with transparent information about current incidents and allows it to monitor the networks in real

time while guaranteeing and monitoring operation. When data is recorded and analysed, it is simultaneously entered into the Industrial IoT, giving the company the opportunity to fully exploit the opportunities offered by digitalisation.

Thanks to its decades of experience, Weidmüller can efficiently support and advise control cabinet builders from the very outset of a project. During a qualification phase for a recent project, Weidmüller initially provided samples so that the Analyser could be put through its paces. This convinced the control cabinet builder just as much as Weidmüller's commercial offer, and led them to include Weidmüller in the tender as a listed supplier. Together they were awarded the contract and were able to implement the project successfully. The project volume for Weidmüller ultimately amounted to a total of 1,400 units.

### **Overview - a real winner for Weidmüller**

- Weidmüller has the right product with the necessary approvals and certifications for monitoring network quality
- Weidmüller provides support right from the start of the project, is on hand to assist in an advisory capacity and supervises the project consistently right through to implementation
- As a large manufacturer, Weidmüller is able to guarantee the delivery of the required high quantities.

### **Outlook**

By providing worldwide support for major projects in the field of power engineering and power distribution, this opens up desirable target markets for Weidmüller. Its extensive portfolio for control cabinet building and power distribution provides control cabinet manufacturers with support on site and establishes Weidmüller in the local energy sector.

# Unique energy monitoring and management solutions

## Implemented with the „Total Energy Monitoring“ range of products

Weidmüller’s „Total Energy Monitoring“ range is a system toolbox comprising components for all levels to measure and monitor the power supply grid, all the way down to the machine level.

The example application below shows potential configurations of hardware and software. These can be tailored to the customer’s requirements, as well as to comply with ISO 50001, EN 50160 or IEC 61000. From the sensor level to the server or cloud level, we offer a comprehensive package of sensors, measuring instruments, gateways and network technologies. Our portfolio is rounded off by our software suite as well as numerous services.





# Reliable monitoring of grid quality

## Certified as class A in accordance with IEC 61000-4-30

There is a direct correlation between the quality of the power supply and the lasting security of supply with no noticeable interruptions. Disruptions and damage are often caused by overvoltage and transients. In addition to a reliable supply, high-quality voltage (\* point 2. in the figure) is crucial to the reliable operation of equipment with all of its electronic consumers, such as industrial control units or EDP facilities. The grid operator must keep the voltage and frequency as constant as possible, and is liable irrespective of culpability in the event of disruptions (\* point 3. in the figure). Precise analysis and documentation using certified procedures are required in order to achieve the greatest possible transparency regarding energy consumption and voltage quality.

### Looking for causes

Voltage quality is becoming relevant for an increasing number of providers and consumers – including in the field of renewable energies. More and more photovoltaic and wind power installations have been connected to the medium-voltage grid over the last decade (\* point 1. in the figure). The grid operators are responsible for the operation of medium-voltage grids. They therefore have a significant interest in monitoring the quality of electricity at the point of connection with equipment.

### Reliable monitoring and error detection

Weidmüller's product portfolio includes the Energy Analyser 750 power quality analyser for comprehensive monitoring. The capabilities it offers allow comprehensive error detection, because in addition to continuously recording consumption it also monitors residual currents. Overvoltage, asymmetries, transients, flicker and other disruption parameters are recorded and analysed. The Energy Analyser 750 complies with all common standards such as EN 50160, IEEE 519 and IEC 61000-2-4, and can be integrated into most communications architectures at low cost thanks to a variety of interfaces.

### Generating relevant results

For monitoring it is advisable to use class-A energy analysis devices, which are connected alongside the charging meters. Only analysers that have been certified as class A ensure that the results are reliable, repeatable and comparable. Because regardless of whether you want to hold a "guilty party" to account for damages incurred or identify and remedy sources of disruption as a precaution, this always requires reliable and documented measurements that even stand up in court if necessary.

### Detailed insights into equipment

The recording of power quality analysers, which Weidmüller has been selling for years, can also be helpful in this regard. Their extensive analyses and documentation provide a detailed insight into a system. In addition to voltage, frequency and curve shape they also record all forms of disruption. These could be flicker effects or brief voltage drops, which are typical for automated reclosure following electric arc short-circuits. Harmonics from non-linear consumers can also significantly impact the function of other devices. Unlike the basic oscillation in the three-phase system, all of the harmonics that are divisible by three in the neutral conductor reinforce each other instead of cancelling each other out. This can cause the current load on the neutral conductor to rise beyond permissible levels. Harmonics are typically mainly generated by frequency converters as well as surge voltages from switching operations.

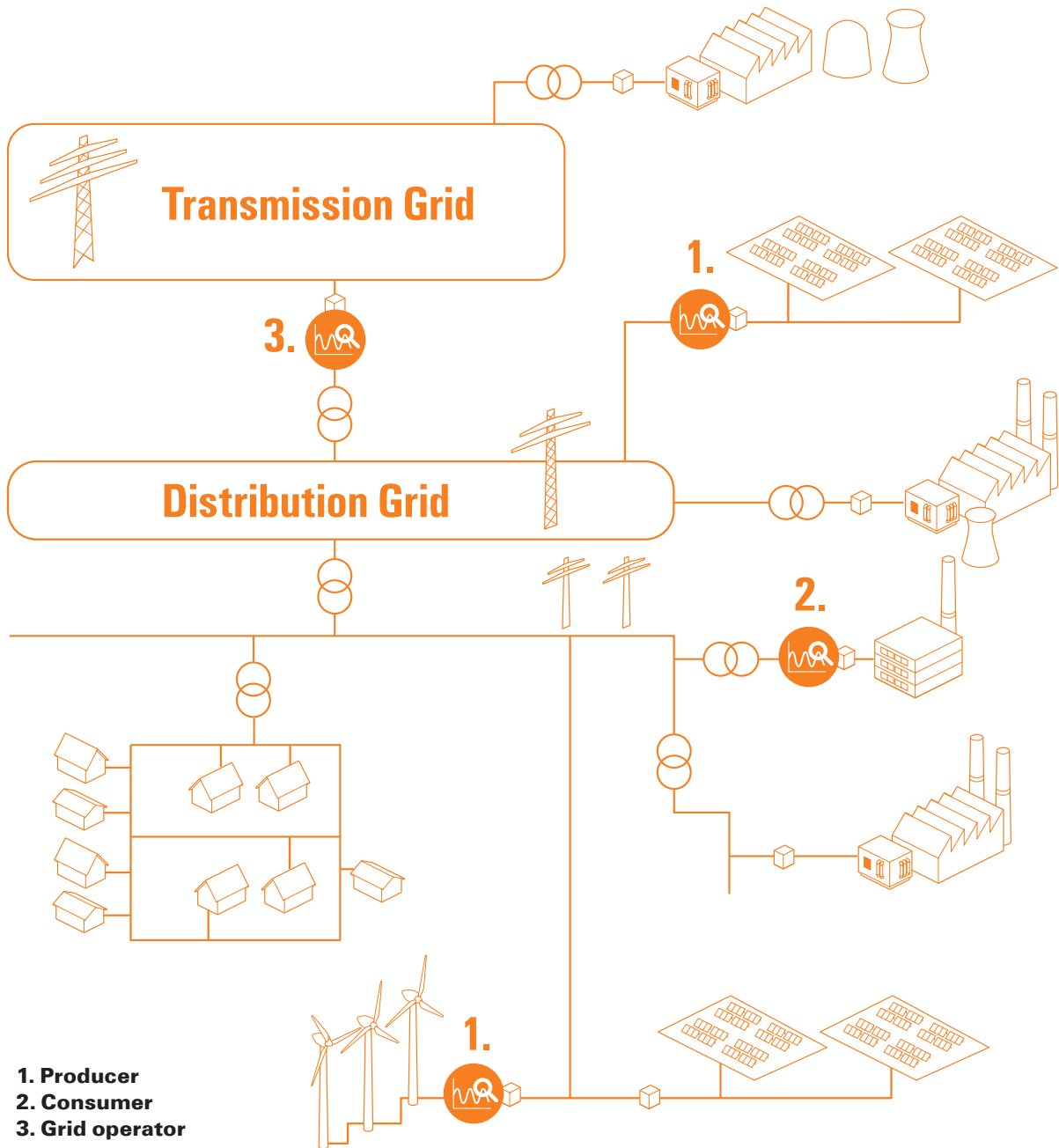

## Reliable residual current measurement

### Use of RCM (Residual Current Monitoring) measuring instruments

Residual currents caused by the failure of insulation can constitute a significant risk to safety in electrical systems. Using an appropriate protective concept it is possible to detect residual currents, eliminate insulation faults in good time and therefore ensure the availability of the system.

RCM stands for Residual Current Monitoring and means the monitoring of residual currents in electrical systems. This current is calculated as the sum of the currents of all conductors, apart from the protective earth (PE), which feed into the system. Residual currents are typically the result of insulation faults, leakage currents or EMC filter leakage currents for example.

Whilst GFI devices (ground fault interrupter) switch off the power supply in the event of a certain residual current being exceeded, RCM measuring devices indicate the actual value, record the long-term development and report the exceeding of a critical value. This message can also be used in order to switch off the power supply via external switching devices (contactors, relays). Through the use of residual current measuring devices it is possible to detect and report residual currents in a timely manner. It is possible to initiate counter measures in good time, so that it is not necessary to switch the system off. This facilitates the implementation of measures in the event of slowly deteriorating insulation values or steadily rising residual currents – caused for example by ageing insulation – before the system is switched off.

Further errors that are detectable by a RCM measurement:

- Insulation faults of lines and electrical operating resources
- Residual currents from electrical loads
- Defective PP power capacitors for the PFC
- Defective components in switched mode power supplies, e.g. in computers
- Correctness of TNS systems (Terra Neutral Separate)
- Disclosure of impermissible PEN connections
- Avoidance of neutral conductor reverse currents to grounded equipment

Residual current monitoring in conjunction with energy measurement in combined energy / RCM measuring devices in electrical systems constitutes a measure for fire protection and maintenance prevention. Down times and the associated costs are thereby reduced. Timely and preventative maintenance – facilitated through the information additionally gained from an RCM measuring device – also significantly enhances the efficiency and availability of a system.

Constant RCM monitoring is of particular significance in preventing unwanted surprises in ongoing operation, and provides consistent information regarding the actual status of the electrical system.

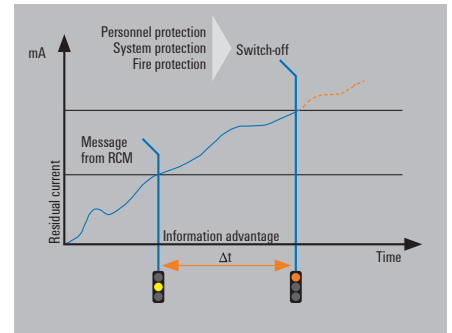
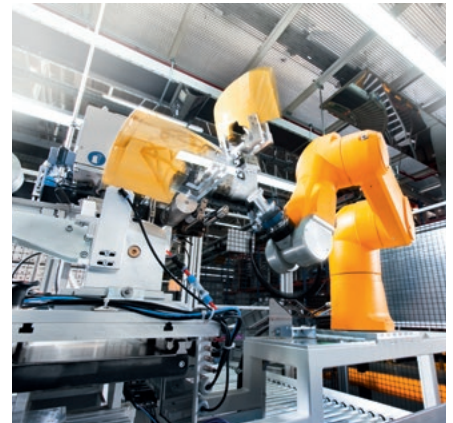
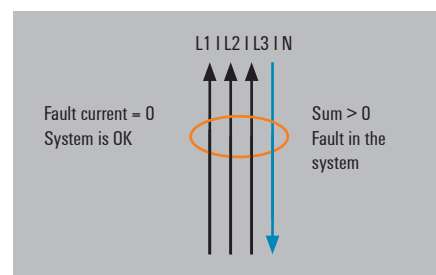

Fig.: Report prior to switching off - an aim of residual current monitoring



### Fundamental measuring process with RCM

The functionality of RCM measuring devices is based on the differential current principle. This requires that all phases be guided through a residual current transformer at the measuring point (outlet to be protected), with the exception of the protective earth. If there is no failure in the system then the sum of all currents will be nil. If, however, residual current is flowing away to ground then the difference will result in the current at the residual current transformer being evaluated by the electronics in the RCM measuring device.



### Typical applications

RCM measuring instruments are mainly used in systems where a high level of availability is required, such as:

- Data processing centres, production facilities, hospitals, telecommunications
- TN-S systems with strict EMC requirements
- Equipment at risk of fire
- Equipment in cleanroom conditions
- Research facilities, laboratory technology areas

Weidmüller combines Energy Management, grid quality and residual current monitoring in a single system, providing you with a holistic solution from medium voltage down to the individual circuit.

### The following measuring instruments support RCM measurement:

- Energy Meter 700-PN
- Energy Meter 750
- Energy Analyser 550
- Energy Analyser 750

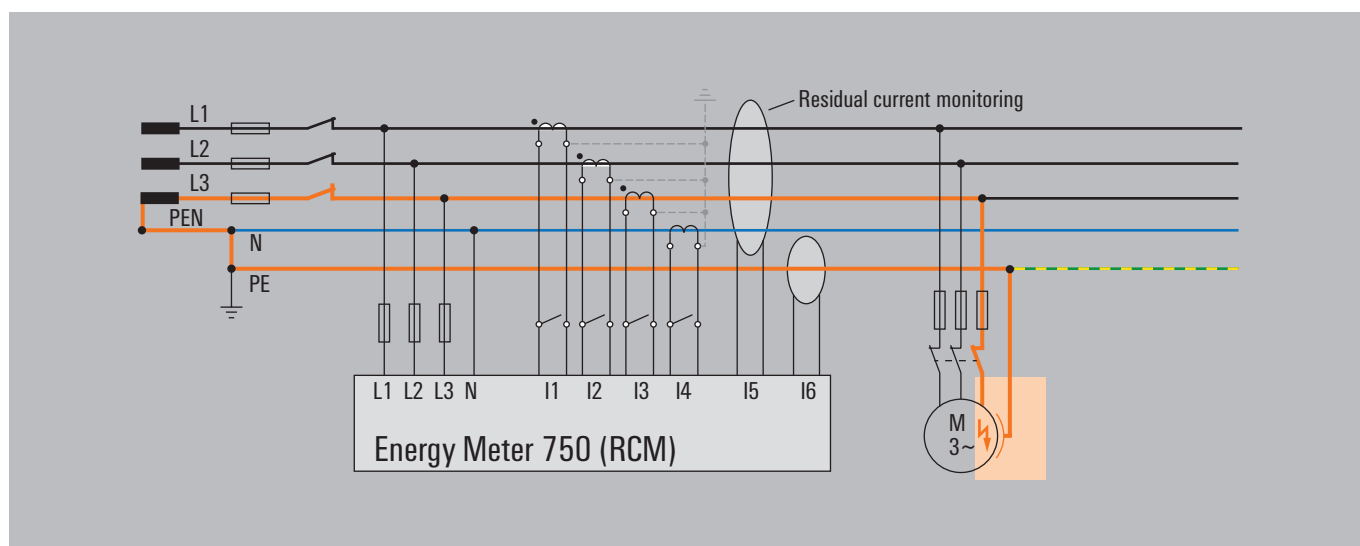

Overview: Energy measurement & analysis devices



Type	EM D370-CBM	EM 520		EM 525		EM 610		EM 610-PB		
		24	230	24	230	24	230	24	230	
Ord. No	2540830000	2500860000	2500880000	2540880000	2540890000	2540920000	2540850000	2540860000	2540870000	
<b>Technical Characteristics</b>										
Measuring range, Voltage L-N, AC (without transducer)	277 V	277 V		277 V		277 V		277 V		
Measuring range, Voltage L-L, AC (without transducer)	480 V	480 V		480 V		480 V		480 V		
Overvoltage category	300 V CAT III	300 V CAT III		300 V CAT III		300 V CAT III		300 V CAT III		
Power supply voltage	-	24 - 90 V AC; 24 - 90 V DC	90 - 277 V AC; 90 - 250 V DC	24 - 90 V AC; 24 - 90 V DC	90 - 277 V AC; 90 - 250 V DC	24 - 90 V AC; 24 - 90 V DC	90 - 277 V AC; 90 - 250 V DC	24 - 90 V AC; 24 - 90 V DC	90 - 277 V AC; 90 - 250 V DC	
Three wire	-	•		•		•		•		
Four wire	•	•		•		•		•		
Quadrants	4	4		4		4		4		
Sampling frequency 50/60 Hz	5.4 kHz	21.33 / 25.6 kHz		21.33 / 25.6 kHz		21.33 / 25.6 kHz		21.33 / 25.6 kHz		
Measurement points per second	5,400	21,330 / 25,600		21,330 / 25,600		21,330 / 25,600		21,330 / 25,600		
Uninterrupted measurement	•	•		•		•		•		
Measurement results per second	5	5		5		5		5		
Effective value from periods (50 / 60 Hz)	10 / 12	10 / 12		10 / 12		10 / 12		10 / 12		
Residual current measurement	-	-		-		-		-		
Harmonics per order / Voltage	1 - 25.	1 - 40.		1 - 40.		1 - 40.		1 - 40.		
Harmonics per order / Current	1 - 25.	1 - 40.		1 - 40.		1 - 40.		1 - 40.		
Distortion factor THD-U in %	•	•		•		•		•		
Distortion factor THD-I in %	•	•		•		•		•		
Unbalance	-	-		-		-		-		
Positive / Negative / zero sequence component	•	•		•		•		•		
Present flicker strength	-	-		-		-		-		
Short / long-term flicker	-	-		-		-		-		
Short-term interruptions, events	-	-		-		-		-		
Accuracy voltage	0.20%	0.20%		0.20%		0.20%		0.20%		
Accuracy current	0.20%	0.20%		0.20%		0.20%		0.20%		
Effective power class	0.5S (.../5A)	0.5S (.../5 A)		0.5S (.../5 A)		0.5S (.../5 A)		0.5S (.../5 A)		
Operating hours counter	•	•		•		•		•		
Weekly timer	-	-		-		-		-		
Number of digital inputs	-	-		-		4		4		
Number of digital outputs	-	2		-		6		6		
Number of pulse outputs	-	2		-		6		6		
Current measurement channel	3	3		3		4		4		
Temperature input	-	-		-		-		-		
Integrated logic	-	Comperator		Comperator		Comperator		Comperator		
Minimum and maximum values for memory	•	•		•		•		•		
Memory size for onboard recording	4 MB Flash	-		-		256 MB		256 MB		
Number of memory values	160 k	-		-		10,000 k		10,000 k		
Clock	•	•		•		•		•		
Bi-metallic function	•	•		•		•		•		
Error / event recorder function	-	-		-		-		-		
Peak demand management (optional)	-	-		-		-		-		
Config Software	ecoExplorer go®	ecoExplorer go®		ecoExplorer go®		ecoExplorer go®		ecoExplorer go®		
update interval register	200 ms	200 ms		200 ms		200 ms		200 ms		
smallest time interval of recording Memory	1 min	-		-		1 min		1 min		
<b>Interfaces</b>										
RS232	-	-		-		-		-		
RS485	•	•		•		•		•		
USB	-	-		-		•		•		
Profibus DP	-	-		-		-		•		
Ethernet	-	-		•		-		-		
Webserver / E-Mail	-	-		-		-		-		
<b>Protocols</b>										
Modbus RTU	•	•		-		•		•		
Modbus-Gateway	-	-		-		-		-		
Profibus DP VO	-	-		-		-		•		
Modbus TCP/IP, Modbus RTU over Ethernet, SNMP	-	-		•		-		-		
BACnet (optional)	-	-		-		-		-		
Profinet	-	-		-		-		-		



EM 750		EM 700-PN		EA D550		EA 550		EA 750		Energy Logger D550
24	230	24	230	24	230	24	230	24	230	
2540900000	2540910000	2500870000	2500890000	2425510000	2489780000	2602580000	2425500000	2534160000	2534130000	2425520000
277 V		277 V		277 V		417 V		347 V		-
480 V		480 V		480 V		720 V (3-Leiter 600 V)		600 V		-
300 V CAT III		300 V CAT III		300 V CAT III		600 V CAT III		600 V CAT III		300 V CAT III
24 - 90 V AC; 24 - 90 V DC	90 - 277 V AC; 90 - 250 V DC	24 - 90 V AC; 24 - 90 V DC	90 - 277 V AC; 90 - 250 V DC	20 - 50 V AC; 20 - 70 V DC	95 - 240 V AC; 135 - 340 V DC	48 - 110 V AC; 24 - 150 V DC	95 - 240 V AC; 80 - 300 V DC	48 - 110 V AC; 24 - 150 V DC	95 - 240 V AC; 80 - 300 V DC	20 - 250 V AC; 20 - 300 V DC
•	•	•	•	•	•	•	•	•	•	-
•	•	•	•	•	•	•	•	•	•	-
4	4	4	4	4	4	4	4	4	4	-
21.33 / 25.6 kHz	21.33 / 25.6 kHz	21.33 / 25.6 kHz	21.33 / 25.6 kHz	20 kHz	20 kHz	20 kHz	20 kHz	20 kHz	25.6 kHz	-
21,330 / 25,600	21,330 / 25,600	21,330 / 25,600	21,330 / 25,600	20,000	20,000	20,000	20,000	20,000	25,600	-
•	•	•	•	•	•	•	•	•	•	-
5	5	5	5	5	5	5	5	5	5	-
10 / 12	10 / 12	10 / 12	10 / 12	10 / 12	10 / 12	10 / 12	10 / 12	10 / 12	10 / 12	-
•	•	•	•	-	-	•	•	•	•	-
1 - 40.	1 - 40.	1 - 40.	1 - 40.	1 - 40.	1 - 40.	1 - 63.	1 - 63.	1 - 63.	1 - 63.	-
1 - 40.	1 - 40.	1 - 40.	1 - 40.	1 - 40.	1 - 40.	1 - 63.	1 - 63.	1 - 63.	1 - 63.	-
•	•	•	•	•	•	•	•	•	•	-
•	•	•	•	•	•	•	•	•	•	-
-	-	-	-	•	•	•	•	•	•	-
•	•	•	•	•	•	•	•	•	•	-
-	-	-	-	-	-	-	-	•	•	-
-	-	-	-	-	-	-	-	•	•	-
•	•	•	•	•	•	•	•	•	•	-
0.20%	0.20%	0.20%	0.20%	0.20%	0.25%	0.10%	0.10%	0.10%	0.10%	-
0.20%	0.20%	0.20%	0.25%	0.25%	0.25%	0.10%	0.10%	0.10%	0.10%	-
0.5S (.../5 A)	0.5S (.../5 A) / 1 (.../1A)	0.5S (.../5 A) / 1 (.../1A)	0.5S (.../5 A) / 1 (.../1A)	0.5S (.../5 A) / 1 (.../1A)	0.5S (.../5 A) / 1 (.../1A)	0.2S (.../5 A)	0.2S (.../5 A)	0.2S (.../5 A)	0.2S (.../5 A)	-
•	•	•	•	•	•	•	•	•	•	•
-	-	-	-	Jasic	Jasic	•	•	•	•	-
3	3	3	3	2	2	2	2	2	2	15
5	5	5	5	2	2	2	2	2	2	3
5	5	5	5	2	2	2	2	2	2	3
4+2	4+2	4+2	4+2	4	4	4+2	4+2	4+2	4+2	-
2	2	2	2	1	1	1	1	1	1	1
Comperator	Comperator	Comperator	Comperator	Jasic®	Jasic®	Jasic®	Jasic®	Jasic®	Jasic®	-
•	•	•	•	•	•	•	•	•	•	•
256 MB	-	-	-	128 MB	128 MB	256 MB	256 MB	256 MB	256 MB	32 MB
10,000 k	-	-	-	5,000 k	5,000 k	10,000 k	10,000 k	10,000 k	10,000 k	-
•	•	•	•	•	•	•	•	•	•	-
•	•	•	•	•	•	•	•	•	•	-
-	-	-	-	•	•	•	•	•	•	-
-	-	-	-	•	•	•	•	•	•	-
ecoExplorer go®	ecoExplorer go®	ecoExplorer go®	ecoExplorer go®	ecoExplorer go®	ecoExplorer go®	ecoExplorer go®	ecoExplorer go®	ecoExplorer go®	ecoExplorer go®	ecoExplorer go®
200 ms	200 ms	200 ms	200 ms	200 ms	200 ms	200 ms	200 ms	200 ms	200 ms	-
1 min	-	-	-	1 min	1 min	1 s	1 s	1 s	1 s	-
-	-	-	-	•	•	-	-	-	-	-
•	•	•	•	•	•	•	•	•	•	•
-	-	-	-	-	-	-	-	-	-	-
•	•	•	•	•	•	•	•	•	•	•
•	•	•	•	•	•	•	•	•	•	•
• / •	• / -	• / -	• / -	• / •	• / •	• / •	• / •	• / •	• / •	-
•	•	•	•	•	•	•	•	•	•	•
•	-	-	-	•	•	•	•	•	•	•
-	-	-	-	-	-	•	•	•	•	-
•	•	•	•	•	•	•	•	•	•	•
•	-	-	-	•	•	•	•	•	•	-
-	•	•	•	-	-	-	-	-	-	-

# Measure energy consumption of production systems in detail

## Weidmüller energy meters make energy efficiency transparent



### Key data at a glance

For devices with integrated display, important measurement data such as voltage, current, power and energy can be easily read off.

### Excellent scalability

The comprehensive range of energy measuring devices means you can break down the energy networks for your production sites as accurately as you wish and measure them in detail.

Energy networks for industrial systems are complex. Our energy meters make it possible to break them down into manageable areas in order to easily analyse consumption and other energy parameters.

Many companies want to protect energy sources, use energy more efficiently and improve the availability of energy networks. This not only demonstrates responsibility, but is also recommended for economical reasons. Weidmüller energy meters can do much more than measure consumption of electrical energy. They can, for example, also determine basic parameters on energy quality or analyse the current from all conductors individually or on a differential basis – such as our Energy Meter 750, for example.

This gives you a quick overview of what is going on with the electrical energy in your production facility. That applies both to efficient use and to quality, stability and availability.

But not all measuring devices are suitable for all applications. You can select the perfect measuring device for each of your system components from our comprehensive, modular portfolio of devices.

# Highest level of compliance with the PROFINET standard

## Weidmüller Energy Meter 700-PN

Depending on the field in which it is being used, a marketable Industrial Ethernet must support functional security as well as the entire range of drive technology through to synchronous motion control with cycle times of less than a millisecond. This is best achieved by cleverly dividing up the protocols using the OSI layer model, as well as using a standard such as PROFINET that is widespread in all mechanical and plant engineering applications.

Costs are already saved at the installation, engineering and commissioning stages thanks to the open and modular PROFINET concept (The operator benefits from the simple expansion and high availability through autonomous subsystems).

### Energy Meter 700-PN – the PROFINET specialist

Our Energy Meter 700-PN has two PROFINET-compliant Ethernet interfaces as well as an integrated switch for building up line topologies. The measurements recorded can be visualised and evaluated in real time using our u-create ResMa® software. Another highlight is the integrated residual current measuring (RCM).



### PROFINET-certified and suitable for the use of PROFlenergy

A PROFINET certificate certifies that our Energy Meter 700-PN complies with IEC 61158 within a PROFINET network, thus ensuring a high standard of quality. It is also suitable for the use of PROFlenergy, a profile for Energy Management in production machinery based on PROFINET. This allows energy consumption within the system to be managed using open and standardised commands. External, hard-wired systems are no longer required.

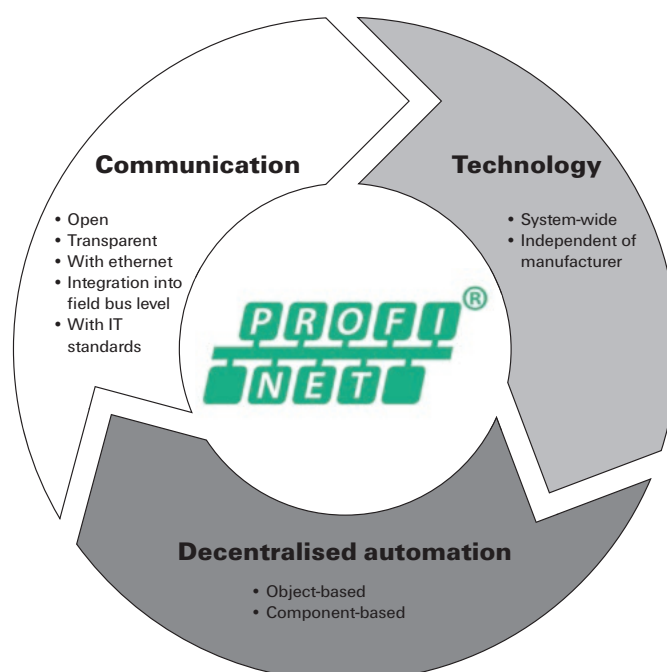

## Energy Meter

## Energy meters for DIN rail mounting

## Energy Meter 370-CBM



## Technical data

Measurement range, voltage L-N, AC	277 V
Measurement range, voltage L-L, AC	480 V
Surge voltage category	300 V CAT III
Voltage supply	
Three-wire system	No
Four-wire system	Yes
Quadrants	4
Sampling frequency 50/60 Hz	5.4 kHz
Continuous measurements	Yes
Effective value from the period (50/60 Hz)	10 / 12
Measurement result per second	5
Residual current measuring	No
Harmonics, per order / voltage	1-25., odd
Harmonics, per order / current	1-25., odd
Unbalanced	No
Positive, negative and zero system	Yes
Measuring accuracy for voltage	0.2 %
Measuring accuracy for current	0.2 %
Measurement accuracy for active energy (kWh, .../5 A)	Class 0.5S
Number of digital inputs	
Number of digital outputs	
Number of pulse outputs	
Current-measuring channels	3
Temperature input	No
Memory; minimum and maximum values	Yes
Memory size	4 MB
Interface	RS485: 9,6 - 115,2 kbps
Protocol	Modbus RTU

## Note

## Ordering data

Type	Qty.	Order No.
ENERGY METER D370-CBM	1	2540830000

## Note

## Accessories

Type	Qty.	Order No.

## Note

Energy meters for front panel mounting

Energy Meter 520-24

Energy Meter 520-230



Technical data

Measurement range, voltage L-N, AC
Measurement range, voltage L-L, AC
Surge voltage category
Voltage supply
Three-wire system
Four-wire system
Quadrants
Sampling frequency 50/60 Hz
Continuous measurements
Effective value from the period (50/60 Hz)
Measurement result per second
Residual current measuring
Harmonics, per order / voltage
Harmonics, per order / current
Unbalanced
Positive, negative and zero system
Measuring accuracy for voltage
Measuring accuracy for current
Measurement accuracy for active energy (kWh, .../5 A)
Number of digital inputs
Number of digital outputs
Number of pulse outputs
Current-measuring channels
Temperature input
Memory; minimum and maximum values
Memory size
Interface
Protocol
<b>Note</b>

277 V
480 V
300 V CAT III
24 - 90 V AC (50/60 Hz), 24 - 90 V DC
Yes
Yes
4
25.6 kHz
Yes
10 / 12
5
No
1-40.
1-40.
No
Yes
0.2 %
0.2 %
Class 0.5S
2
2
3
No
Yes
RS485: 9,6 - 115,2 kbps
Modbus RTU
<b>Note</b>

277 V
480 V
300 V CAT III
90 - 277 V AC (50/60 Hz), 90 - 250 V DC
Yes
Yes
4
25.6 kHz
Yes
10 / 12
5
No
1-40.
1-40.
No
Yes
0.2 %
0.2 %
Class 0.5S
2
2
3
No
Yes
RS485: 9,6 - 115,2 kbps
Modbus RTU
<b>Note</b>

Ordering data

<b>Note</b>
-------------

Type	Qty.	Order No.
ENERGY METER 520-24	1	2500860000

Type	Qty.	Order No.
ENERGY METER 520-230	1	2500880000

Accessories

DIN rail adapters
Seal
Fixing clamps

	Qty.	Order No.
ENERGY METER BRACKET S2	1	2433070000
ENERGY METER SEAL L96-2	1	2495610000
ENERGY METER FIXING SET	1	2433030000

	Qty.	Order No.
ENERGY METER BRACKET S2	1	2433070000
ENERGY METER SEAL L96-2	1	2495610000
ENERGY METER FIXING SET	1	2433030000

<b>Note</b>
-------------

<b>Note</b>
-------------

<b>Note</b>
-------------

Energy meters for front panel mounting

Energy Meter 525-24



Energy Meter 525-230



Technical data

Measurement range, voltage L-N, AC
Measurement range, voltage L-L, AC
Surge voltage category
Voltage supply
Three-wire system
Four-wire system
Quadrants
Sampling frequency 50/60 Hz
Continuous measurements
Effective value from the period (50/60 Hz)
Measurement result per second
Residual current measuring
Harmonics, per order / voltage
Harmonics, per order / current
Unbalanced
Positive, negative and zero system
Measuring accuracy for voltage
Measuring accuracy for current
Measurement accuracy for active energy (kWh, .../5 A)
Number of digital inputs
Number of digital outputs
Number of pulse outputs
Current-measuring channels
Temperature input
Memory; minimum and maximum values
Memory size
Interface
Protocol
<b>Note</b>

277 V
480 V
300 V CAT III
24 - 90 V AC (50/60 Hz), 24 - 90 V DC
Yes
Yes
4
25.6 kHz
Yes
10 / 12
5
No
1-40.
1-40.
No
Yes
0.2 %
0.2 %
Class 0.5S
3
No
Yes
Ethernet
Modbus TCP/IP, Modbus RTU over Ethernet, SNMP
<b>Note</b>

277 V
480 V
300 V CAT III
90 - 277 V AC (50/60 Hz), 90 - 250 V DC
Yes
Yes
4
25.6 kHz
Yes
10 / 12
5
No
1-40.
1-40.
No
Yes
0.2 %
0.2 %
Class 0.5S
3
No
Yes
Ethernet
Modbus TCP/IP, Modbus RTU over Ethernet, SNMP
<b>Note</b>

Ordering data

<b>Note</b>
-------------

Type	Qty.	Order No.
ENERGY METER 525-24	1	2540880000

Type	Qty.	Order No.
ENERGY METER 525-230	1	2540890000

Accessories

DIN rail adapters
Seal
Fixing clamps

	Qty.	Order No.
ENERGY METER BRACKET L1	1	2433060000
ENERGY METER SEAL L96-2	1	2495610000
ENERGY METER FIXING SET	1	2433030000

	Qty.	Order No.
ENERGY METER BRACKET L1	1	2433060000
ENERGY METER SEAL L96-2	1	2495610000
ENERGY METER FIXING SET	1	2433030000

<b>Note</b>
-------------

<b>Note</b>
-------------

<b>Note</b>
-------------

Energy meters for front panel mounting

Energy Meter 610-24



Energy Meter 610-230



Technical data

Measurement range, voltage L-N, AC	277 V
Measurement range, voltage L-L, AC	480 V
Surge voltage category	300 V CAT III
Voltage supply	24 - 90 V AC (50/60 Hz), 24 - 90 V DC
Three-wire system	Yes
Four-wire system	Yes
Quadrants	4
Sampling frequency 50/60 Hz	25.6 kHz
Continuous measurements	Yes
Effective value from the period (50/60 Hz)	10 / 12
Measurement result per second	5
Residual current measuring	No
Harmonics, per order / voltage	1-40.
Harmonics, per order / current	1-40.
Unbalanced	No
Positive, negative and zero system	Yes
Measuring accuracy for voltage	0.2 %
Measuring accuracy for current	0.2 %
Measurement accuracy for active energy (kWh, .../5 A)	Class 0.5S
Number of digital inputs	4
Number of digital outputs	6
Number of pulse outputs	6
Current-measuring channels	4
Temperature input	No
Memory; minimum and maximum values	Yes
Memory size	256 MB
Interface	RS485: 9,6 - 115,2 kbps, USB
Protocol	Modbus RTU
<b>Note</b>	

Measurement range, voltage L-N, AC	277 V
Measurement range, voltage L-L, AC	480 V
Surge voltage category	300 V CAT III
Voltage supply	24 - 90 V AC (50/60 Hz), 24 - 90 V DC
Three-wire system	Yes
Four-wire system	Yes
Quadrants	4
Sampling frequency 50/60 Hz	25.6 kHz
Continuous measurements	Yes
Effective value from the period (50/60 Hz)	10 / 12
Measurement result per second	5
Residual current measuring	No
Harmonics, per order / voltage	1-40.
Harmonics, per order / current	1-40.
Unbalanced	No
Positive, negative and zero system	Yes
Measuring accuracy for voltage	0.2 %
Measuring accuracy for current	0.2 %
Measurement accuracy for active energy (kWh, .../5 A)	Class 0.5S
Number of digital inputs	4
Number of digital outputs	6
Number of pulse outputs	6
Current-measuring channels	4
Temperature input	No
Memory; minimum and maximum values	Yes
Memory size	256 MB
Interface	RS485: 9,6 - 115,2 kbps, USB
Protocol	Modbus RTU
<b>Note</b>	

Measurement range, voltage L-N, AC	277 V
Measurement range, voltage L-L, AC	480 V
Surge voltage category	300 V CAT III
Voltage supply	90 - 277 V AC (50/60 Hz), 90 - 250 V DC
Three-wire system	Yes
Four-wire system	Yes
Quadrants	4
Sampling frequency 50/60 Hz	25.6 kHz
Continuous measurements	Yes
Effective value from the period (50/60 Hz)	10 / 12
Measurement result per second	5
Residual current measuring	No
Harmonics, per order / voltage	1-40.
Harmonics, per order / current	1-40.
Unbalanced	No
Positive, negative and zero system	Yes
Measuring accuracy for voltage	0.2 %
Measuring accuracy for current	0.2 %
Measurement accuracy for active energy (kWh, .../5 A)	Class 0.5S
Number of digital inputs	4
Number of digital outputs	6
Number of pulse outputs	6
Current-measuring channels	4
Temperature input	No
Memory; minimum and maximum values	Yes
Memory size	256 MB
Interface	RS485: 9,6 - 115,2 kbps, USB
Protocol	Modbus RTU
<b>Note</b>	

Ordering data

<b>Note</b>	
-------------	--

Type	Qty.	Order No.
ENERGY METER 610-24	1	2540920000

Type	Qty.	Order No.
ENERGY METER 610-230	1	2540850000

Accessories

DIN rail adapters
Seal
Fixing clamps

	Qty.	Order No.
ENERGY METER BRACKET L1	1	2433060000
ENERGY METER SEAL L96-2	1	2495610000
ENERGY METER FIXING SET	1	2433030000

	Qty.	Order No.
ENERGY METER BRACKET L1	1	2433060000
ENERGY METER SEAL L96-2	1	2495610000
ENERGY METER FIXING SET	1	2433030000

<b>Note</b>	
-------------	--

<b>Note</b>	
-------------	--

<b>Note</b>	
-------------	--

Energy meters for front panel mounting

Energy Meter 610 PB-24

Energy Meter 610 PB-230



Technical data

Measurement range, voltage L-N, AC	277 V
Measurement range, voltage L-L, AC	480 V
Surge voltage category	300 V CAT III
Voltage supply	24 - 90 V AC (50/60 Hz), 24 - 90 V DC
Three-wire system	Yes
Four-wire system	Yes
Quadrants	4
Sampling frequency 50/60 Hz	25.6 kHz
Continuous measurements	Yes
Effective value from the period (50/60 Hz)	10 / 12
Measurement result per second	5
Residual current measuring	No
Harmonics, per order / voltage	1-40.
Harmonics, per order / current	1-40.
Unbalanced	No
Positive, negative and zero system	Yes
Measuring accuracy for voltage	0.2 %
Measuring accuracy for current	0.2 %
Measurement accuracy for active energy (kWh, .../5 A)	Class 0.5S
Number of digital inputs	4
Number of digital outputs	6
Number of pulse outputs	6
Current-measuring channels	4
Temperature input	No
Memory; minimum and maximum values	Yes
Memory size	256 MB
Interface	RS485: 9,6 - 115,2 kbps, Profibus DP, USB
Protocol	Modbus RTU, Profibus DP V0
<b>Note</b>	

Measurement range, voltage L-N, AC	277 V
Measurement range, voltage L-L, AC	480 V
Surge voltage category	300 V CAT III
Voltage supply	24 - 90 V AC (50/60 Hz), 24 - 90 V DC
Three-wire system	Yes
Four-wire system	Yes
Quadrants	4
Sampling frequency 50/60 Hz	25.6 kHz
Continuous measurements	Yes
Effective value from the period (50/60 Hz)	10 / 12
Measurement result per second	5
Residual current measuring	No
Harmonics, per order / voltage	1-40.
Harmonics, per order / current	1-40.
Unbalanced	No
Positive, negative and zero system	Yes
Measuring accuracy for voltage	0.2 %
Measuring accuracy for current	0.2 %
Measurement accuracy for active energy (kWh, .../5 A)	Class 0.5S
Number of digital inputs	4
Number of digital outputs	6
Number of pulse outputs	6
Current-measuring channels	4
Temperature input	No
Memory; minimum and maximum values	Yes
Memory size	256 MB
Interface	RS485: 9,6 - 115,2 kbps, Profibus DP, USB
Protocol	Modbus RTU, Profibus DP V0
<b>Note</b>	

Measurement range, voltage L-N, AC	277 V
Measurement range, voltage L-L, AC	480 V
Surge voltage category	300 V CAT III
Voltage supply	90 - 277 V AC (50/60 Hz), 90 - 250 V DC
Three-wire system	Yes
Four-wire system	Yes
Quadrants	4
Sampling frequency 50/60 Hz	25.6 kHz
Continuous measurements	Yes
Effective value from the period (50/60 Hz)	10 / 12
Measurement result per second	5
Residual current measuring	No
Harmonics, per order / voltage	1-40.
Harmonics, per order / current	1-40.
Unbalanced	No
Positive, negative and zero system	Yes
Measuring accuracy for voltage	0.2 %
Measuring accuracy for current	0.2 %
Measurement accuracy for active energy (kWh, .../5 A)	Class 0.5S
Number of digital inputs	4
Number of digital outputs	6
Number of pulse outputs	6
Current-measuring channels	4
Temperature input	No
Memory; minimum and maximum values	Yes
Memory size	256 MB
Interface	RS485: 9,6 - 115,2 kbps, Profibus DP, USB
Protocol	Modbus RTU, Profibus DP V0
<b>Note</b>	

Ordering data

<b>Note</b>	
-------------	--

Type	Qty.	Order No.
ENERGY METER 610-PB-24	1	2540860000

Type	Qty.	Order No.
ENERGY METER 610-PB-230	1	2540870000

Accessories

DIN rail adapters	
Seal	
Fixing clamps	

	Qty.	Order No.
ENERGY METER BRACKET L1	1	2433060000
ENERGY METER SEAL L96-2	1	2495610000
ENERGY METER FIXING SET	1	2433030000

	Qty.	Order No.
ENERGY METER BRACKET L1	1	2433060000
ENERGY METER SEAL L96-2	1	2495610000
ENERGY METER FIXING SET	1	2433030000

<b>Note</b>	
-------------	--

<b>Note</b>	
-------------	--

<b>Note</b>	
-------------	--

Energy meters for front panel mounting

Energy Meter 700 PN-24

Energy Meter 700 PN-230



Technical data

Measurement range, voltage L-N, AC
Measurement range, voltage L-L, AC
Surge voltage category
Voltage supply
Three-wire system
Four-wire system
Quadrants
Sampling frequency 50/60 Hz
Continuous measurements
Effective value from the period (50/60 Hz)
Measurement result per second
Residual current measuring
Harmonics, per order / voltage
Harmonics, per order / current
Unbalanced
Positive, negative and zero system
Measuring accuracy for voltage
Measuring accuracy for current
Measurement accuracy for active energy (kWh, .../5 A)
Number of digital inputs
Number of digital outputs
Number of pulse outputs
Current-measuring channels
Temperature input
Memory; minimum and maximum values
Memory size
Interface
Protocol

277 V
480 V
300 V CAT III
24 - 90 V AC (50/60 Hz), 24 - 90 V DC
Yes
Yes
4
25.6 kHz
Yes
10 / 12
5
Yes
1-40.
1-40.
No
Yes
0.2 %
0.2 %
Class 0.5S
3
5
5
4 + 2
Yes
Yes
RS485: 9,6 - 115,2 kbps, Ethernet, Web server
PROFINET, Modbus RTU, Modbus TCP/IP, Modbus RTU over Ethernet, SNMP

277 V
480 V
300 V CAT III
90 - 277 V AC (50/60 Hz), 90 - 250 V DC
Yes
Yes
4
25.6 kHz
Yes
10 / 12
5
Yes
1-40.
1-40.
No
Yes
0.2 %
0.2 %
Class 0.5S
3
5
5
4 + 2
Yes
Yes
RS485: 9,6 - 115,2 kbps, Ethernet, Web server
PROFINET, Modbus RTU, Modbus TCP/IP, Modbus RTU over Ethernet, SNMP

Note

Ordering data

Note
------

Type	Qty.	Order No.
ENERGY METER 700-PN-24	1	2500870000

Type	Qty.	Order No.
ENERGY METER 700-PN-230	1	2500890000

Accessories

DIN rail adapters
Seal
Fixing clamps

	Qty.	Order No.
ENERGY METER BRACKET L1	1	2433060000
ENERGY METER SEAL L96-2	1	2495610000
ENERGY METER FIXING SET	1	2433030000

	Qty.	Order No.
ENERGY METER BRACKET L1	1	2433060000
ENERGY METER SEAL L96-2	1	2495610000
ENERGY METER FIXING SET	1	2433030000

Note

Energy meters for front panel mounting

Energy Meter 750-24

Energy Meter 750-230



Technical data

Measurement range, voltage L-N, AC	277 V
Measurement range, voltage L-L, AC	480 V
Surge voltage category	300 V CAT III
Voltage supply	24 - 90 V AC (50/60 Hz), 24 - 90 V DC
Three-wire system	Yes
Four-wire system	Yes
Quadrants	4
Sampling frequency 50/60 Hz	25.6 kHz
Continuous measurements	Yes
Effective value from the period (50/60 Hz)	10 / 12
Measurement result per second	5
Residual current measuring	Yes
Harmonics, per order / voltage	1-40.
Harmonics, per order / current	1-40.
Unbalanced	No
Positive, negative and zero system	Yes
Measuring accuracy for voltage	0.2 %
Measuring accuracy for current	0.2 %
Measurement accuracy for active energy (kWh, .../5 A)	Class 0.5S
Number of digital inputs	3
Number of digital outputs	5
Number of pulse outputs	5
Current-measuring channels	4 + 2
Temperature input	Yes
Memory; minimum and maximum values	Yes
Memory size	256 MB
Interface	RS485: 9,6 - 115,2 kbps, Ethernet, Web server/e-mail
Protocol	Modbus RTU, Modbus-Gateway, Modbus TCP/IP, Modbus RTU over Ethernet, SNMP, BACnet (optional)
Note	

Measurement range, voltage L-N, AC	277 V
Measurement range, voltage L-L, AC	480 V
Surge voltage category	300 V CAT III
Voltage supply	24 - 90 V AC (50/60 Hz), 24 - 90 V DC
Three-wire system	Yes
Four-wire system	Yes
Quadrants	4
Sampling frequency 50/60 Hz	25.6 kHz
Continuous measurements	Yes
Effective value from the period (50/60 Hz)	10 / 12
Measurement result per second	5
Residual current measuring	Yes
Harmonics, per order / voltage	1-40.
Harmonics, per order / current	1-40.
Unbalanced	No
Positive, negative and zero system	Yes
Measuring accuracy for voltage	0.2 %
Measuring accuracy for current	0.2 %
Measurement accuracy for active energy (kWh, .../5 A)	Class 0.5S
Number of digital inputs	3
Number of digital outputs	5
Number of pulse outputs	5
Current-measuring channels	4 + 2
Temperature input	Yes
Memory; minimum and maximum values	Yes
Memory size	256 MB
Interface	RS485: 9,6 - 115,2 kbps, Ethernet, Web server/e-mail
Protocol	Modbus RTU, Modbus-Gateway, Modbus TCP/IP, Modbus RTU over Ethernet, SNMP, BACnet (optional)
Note	

Measurement range, voltage L-N, AC	277 V
Measurement range, voltage L-L, AC	480 V
Surge voltage category	300 V CAT III
Voltage supply	90 - 277 V AC (50/60 Hz), 90 - 250 V DC
Three-wire system	Yes
Four-wire system	Yes
Quadrants	4
Sampling frequency 50/60 Hz	25.6 kHz
Continuous measurements	Yes
Effective value from the period (50/60 Hz)	10 / 12
Measurement result per second	5
Residual current measuring	Yes
Harmonics, per order / voltage	1-40.
Harmonics, per order / current	1-40.
Unbalanced	No
Positive, negative and zero system	Yes
Measuring accuracy for voltage	0.2 %
Measuring accuracy for current	0.2 %
Measurement accuracy for active energy (kWh, .../5 A)	Class 0.5S
Number of digital inputs	3
Number of digital outputs	5
Number of pulse outputs	5
Current-measuring channels	4 + 2
Temperature input	Yes
Memory; minimum and maximum values	Yes
Memory size	256 MB
Interface	RS485: 9,6 - 115,2 kbps, Ethernet, Web server/e-mail
Protocol	Modbus RTU, Modbus-Gateway, Modbus TCP/IP, Modbus RTU over Ethernet, SNMP, BACnet (optional)
Note	

Ordering data

Note	
------	--

Type	Qty.	Order No.
ENERGY METER 750-24	1	2540900000

Type	Qty.	Order No.
ENERGY METER 750-230	1	2540910000

Accessories

DIN rail adapters	
Seal	
Fixing clamps	

	Qty.	Order No.
ENERGY METER BRACKET L1	1	2433060000
ENERGY METER SEAL L96-2	1	2495610000
ENERGY METER FIXING SET	1	2433030000

	Qty.	Order No.
ENERGY METER BRACKET L1	1	2433060000
ENERGY METER SEAL L96-2	1	2495610000
ENERGY METER FIXING SET	1	2433030000

Note	
------	--

Note	
------	--

Note	
------	--

Energy meters for front panel mounting

Power Monitor

Power Monitor 51 A



Technical data

<b>General data</b>	
Voltage supply	100...240 V AC, 100...300 V DC
Measurement accuracy for active energy (kWh, .../5 A)	1% for the calculated values
<b>Measuring-voltage input</b>	
Three-wire system	Yes
Four-wire system	Yes
Measurement range, voltage L-L, AC	0...500 V
Measurement range, voltage L-N, AC	0...250 V (1P3W), 0...289 V (3P4W)
Measuring accuracy for voltage	1 %
<b>Measuring-current input</b>	
Rated current	1 / 5 A
Residual current measuring	No
Measuring accuracy for current	0.5 %
Current-measuring channels	3
<b>Inputs / Outputs</b>	
Number of digital inputs	
Number of digital outputs	
<b>Communication</b>	
Interface	RS485: Autobaud, 9,6 - 115.2 kbps (pluggable screw terminals)
Protocol	Modbus RTU
<b>Mechanical specifications</b>	
Height / Width / Depth	96 / 96 / 68 mm
<b>Environmental conditions</b>	
Operating temperature	-25...55 °C
Humidity	35 % to 85 % relative humidity level
<b>Note</b>	

<b>General data</b>		
Voltage supply	Qty.	Order No.
100...240 V AC, 100...300 V DC	1	1423550000
<b>Measuring-voltage input</b>		
Measurement accuracy for active energy (kWh, .../5 A)	Qty.	Order No.
1% for the calculated values	1	1423550000
<b>Measuring-current input</b>		
Rated current	Qty.	Order No.
1 / 5 A	1	1423550000
<b>Inputs / Outputs</b>		
Number of digital inputs	Qty.	Order No.
	2	
Number of digital outputs	Qty.	Order No.
	2	
<b>Communication</b>		
Interface	Qty.	Order No.
RS485: Autobaud, 9,6 - 115.2 kbps (pluggable screw terminals)	1	1423550000
Protocol	Qty.	Order No.
Modbus RTU	1	1423550000
<b>Mechanical specifications</b>		
Height / Width / Depth	Qty.	Order No.
96 / 96 / 68 mm	1	1423550000
<b>Environmental conditions</b>		
Operating temperature	Qty.	Order No.
-25...55 °C	1	1423550000
Humidity	Qty.	Order No.
35 % to 85 % relative humidity level	1	1423550000
<b>Note</b>		

<b>General data</b>		
Voltage supply	Qty.	Order No.
85...264 V AC, 100...300 V DC	1	1470260000
<b>Measuring-voltage input</b>		
Measurement accuracy for active energy (kWh, .../5 A)	Qty.	Order No.
1% for the calculated values	1	1470260000
<b>Measuring-current input</b>		
Rated current	Qty.	Order No.
1 / 5 A	1	1470260000
<b>Inputs / Outputs</b>		
Number of digital inputs	Qty.	Order No.
	2	
Number of digital outputs	Qty.	Order No.
	2	
<b>Communication</b>		
Interface	Qty.	Order No.
RS485: Autobaud, 9,6 - 115.2 kbps (pluggable screw terminals), USB	1	1470260000
Protocol	Qty.	Order No.
Modbus RTU	1	1470260000
<b>Mechanical specifications</b>		
Height / Width / Depth	Qty.	Order No.
96 / 96 / 68 mm	1	1470260000
<b>Environmental conditions</b>		
Operating temperature	Qty.	Order No.
-25...55 °C	1	1470260000
Humidity	Qty.	Order No.
35 % to 85 % relative humidity level	1	1470260000
<b>Note</b>		

Ordering data

<b>Note</b>	
-------------	--

Type	Qty.	Order No.
POWER MONITOR	1	1423550000

Type	Qty.	Order No.
POWER MONITOR 51A	1	1470260000

Accessories

DIN rail adapters
-------------------

	Qty.	Order No.
POWER MONITOR BRACKET	1	2091060000

	Qty.	Order No.
POWER MONITOR BRACKET	1	2091060000

<b>Note</b>
-------------

<b>Note</b>
-------------

<b>Note</b>
-------------

# Holistic analysis of the quality of electrical supply networks

## Energy analyser for transparency and improved plant availability



The quality of the electrical network is an important parameter for the effectiveness and availability of industrial plants and production facilities. The Energy Analyser 750 is the first step towards increased added value and is particularly suitable for monitoring power quality according to common standards such as EN 50160, IEEE 519 or IEC 61000-2-4.

An increasing number of non-linear consumers and plant components are being used in production facilities. They have an impact on, for example, network frequency, phase shift and the amplitude of phases. This influences the quality of the electrical energy and thus the uptime of the plant. The new Energy Analyser 750 measures all quality parameters of the electrical supply network, from the symmetry to transients and many other parameters besides.

### Integrated monitoring of residual current

The built-in residual current measurement highlights creeping increases in residual current before fuses or residual current detectors switch off the section of the system. This maximizes operating times.

### Large, clear display

The large QVGA colour display on the device clearly visualises all measurement parameters and allows convenient adjustment of the system parameters.

### Top-hat rail devices for simple requirements

For less comprehensive measurements, we offer the Energy Analyser D550, a very small device for installation on standard DIN rails.



With the Energy Analyser 750, you can carry out comprehensive checks on the quality of the electrical energy in your production facility and initiate optimization steps to maximize the effectiveness and availability of your plant. Important events can be recorded as required.

# Continuously monitoring voltage quality

## Standard-compliant measurements with the Energy Analyser 750

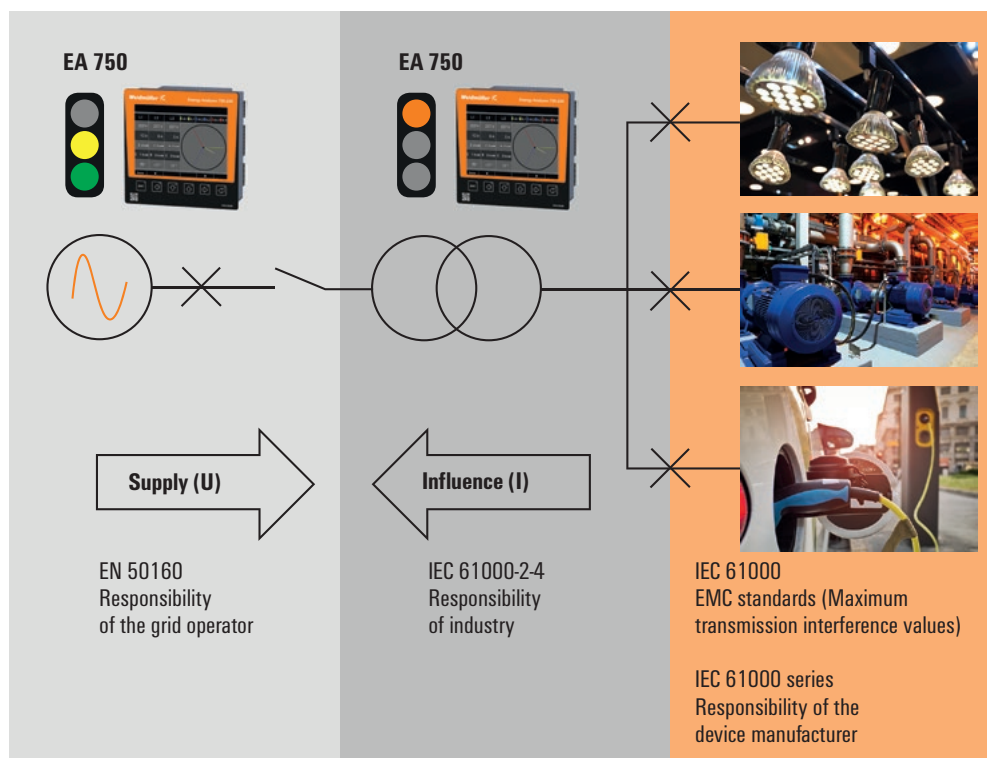

### Power quality – standards and guidelines

Within Europe, EN 50160 is the standard for describing the quality of an electrical power supply. The standard mainly describes the characteristics of the supply voltage at the point of supply to the customer in public low and medium voltage networks under normal operating conditions. EN 50160 applies to the grid voltage, i.e. the voltage measured at the point of connection with the grid. A voltage distortion in the public grid distorts the voltage in the industrial grid, and should therefore be monitored continuously.

The IEC 61000-2-4 standard defines numerical thresholds for industrial and non-public electricity distribution systems with nominal voltages of up to 35 kV. The IEC 61000-2-4 standard should apply to the quality of the voltage at the point of supply to the consumer. That is why it serves as the basis for many product and machinery design standards.

It defines the immunity levels for voltage distortions that machinery and systems in industrial enterprises need to be able to withstand.

If the level is exceeded, this may result in outages that the machinery or system supplier is not liable for. Monitoring in accordance with IEC 61000-2-4 is therefore advisable. New standards such as EN 50600-2-2 for electrical systems in data processing centres also require voltage quality in accordance with EN 50160 and IEC 61000-2-4.

The Energy Analyser 750 facilitates the comprehensive monitoring of specific parameters of voltage quality, and supports compliance with all required standards.

## Energy analyser

## Energy analyser

## Energy Analyser D550-24



## Energy Analyser D550-230



## Technical data

Measurement range, voltage L-N, AC
Measurement range, voltage L-L, AC
Surge voltage category
Voltage supply
Three-wire system
Four-wire system
Quadrants
Sampling frequency 50/60 Hz
Continuous measurements
Effective value from the period (50/60 Hz)
Measurement result per second
Residual current measuring
Harmonics, per order / voltage
Harmonics, per order / current
Unbalanced
Positive, negative and zero system
Measuring accuracy for voltage
Measuring accuracy for current
Measurement accuracy for active energy (kWh, .../5 A)
Number of digital inputs
Number of digital outputs
Number of pulse outputs
Current-measuring channels
Temperature input
Memory; minimum and maximum values
Memory size
Interface

277 V
480 V
300 V CAT III
20 ... 50 V AC $\pm 10\%$ , 20 ... 70 V DC $\pm 10\%$
Yes
Yes
4
20 kHz
Yes
10 / 12
5
No
1-40.
1-40.
Yes
Yes
0.2 %
0.25 %
Class 0.5S
2
2
2
4
Yes
Yes
128 MB
RS232: 9.6 - 115.2 kbps, RS485: 9.6 - 921.6 kbps, Ethernet, Web server/e-mail

277 V
480 V
300 V CAT III
95 - 240 V AC, 135 - 340 V DC
Yes
Yes
4
20 kHz
Yes
10 / 12
5
No
1-40.
1-40.
Yes
Yes
0.2 %
0.25 %
Class 0.5S
2
2
2
4
Yes
Yes
128 MB
RS232: 9.6 - 115.2 kbps, RS485: 9.6 - 921.6 kbps, Ethernet, Web server/e-mail

Protocol

Modbus RTU, Modbus-Gateway, Modbus TCP/IP, Modbus RTU over Ethernet, SNMP, BACnet (optional)

Modbus RTU, Modbus-Gateway, Modbus TCP/IP, Modbus RTU over Ethernet, SNMP, BACnet (optional)

Note

## Ordering data

Type	Qty.	Order No.
ENERGY ANALYSER D550-24	1	2489780000

Type	Qty.	Order No.
ENERGY ANALYSER D550	1	2425510000

Note

## Accessories

Type	Qty.	Order No.
------	------	-----------

Type	Qty.	Order No.
------	------	-----------

Note

Energy analyser

Energy Analyser 550-24

Energy Analyser 550-230



Technical data

Measurement range, voltage L-N, AC
Measurement range, voltage L-L, AC
Surge voltage category
Voltage supply
Three-wire system
Four-wire system
Quadrants
Sampling frequency 50/60 Hz
Continuous measurements
Effective value from the period (50/60 Hz)
Measurement result per second
Residual current measuring
Harmonics, per order / voltage
Harmonics, per order / current
Unbalanced
Positive, negative and zero system
Measuring accuracy for voltage
Measuring accuracy for current
Measurement accuracy for active energy (kWh, .../5 A)
Number of digital inputs
Number of digital outputs
Number of pulse outputs
Current-measuring channels
Temperature input
Memory; minimum and maximum values
Memory size
Interface
Protocol
<b>Note</b>

417 V
720 V
600 V CAT III
48...110 V AC, 24...150 V DC
Yes
Yes
4
20 kHz
Yes
10 / 12
5
Yes
1-63.
1-63.
Yes
Yes
0.1 %
0.2 %
Class 0.2S
2
2
2
4 + 2
Yes
Yes
256 MB
RS485: 9.6 - 921.6 kbps, Profibus DP, Ethernet, Web server/e-mail
Modbus RTU, Modbus-Gateway, Modbus TCP/IP, Modbus RTU over Ethernet, SNMP, Profibus DP V0, BACnet (optional)
<b>Note</b>

417 V
720 V
600 V CAT III
95 - 240 V AC, 80 - 300 V DC
Yes
Yes
4
20 kHz
Yes
10 / 12
5
Yes
1-63.
1-63.
Yes
Yes
0.1 %
0.2 %
Class 0.2S
2
2
2
4 + 2
Yes
Yes
256 MB
RS485: 9.6 - 921.6 kbps, Profibus DP, Ethernet, Web server/e-mail
Modbus RTU, Modbus-Gateway, Modbus TCP/IP, Modbus RTU over Ethernet, SNMP, Profibus DP V0, BACnet (optional)
<b>Note</b>

Ordering data

<b>Note</b>
-------------

Type	Qty.	Order No.
ENERGY ANALYSER 550-24	1	2602580000

Type	Qty.	Order No.
ENERGY ANALYSER 550	1	2425500000

Accessories

DIN rail adapters
Seal

	Qty.	Order No.
ENERGY METER BRACKET B1	1	2433040000
ENERGY METER SEAL L144	1	2495630000

	Qty.	Order No.
ENERGY METER BRACKET B1	1	2433040000
ENERGY METER SEAL L144	1	2495630000

<b>Note</b>
-------------

<b>Note</b>
-------------

<b>Note</b>
-------------

## Energy analyser

## Energy Analyser 750-24



## Energy Analyser 750-230



## Technical data

Measurement range, voltage L-N, AC	347 V
Measurement range, voltage L-L, AC	600 V
Surge voltage category	600 V CAT III
Voltage supply	48...110 V AC, 24...150 V DC
Three-wire system	Yes
Four-wire system	Yes
Quadrants	4
Sampling frequency 50/60 Hz	25.6 kHz
Continuous measurements	Yes
Effective value from the period (50/60 Hz)	10 / 12
Measurement result per second	5
Residual current measuring	Yes
Harmonics, per order / voltage	1-63.
Harmonics, per order / current	1-63.
Unbalanced	Yes
Positive, negative and zero system	Yes
Measuring accuracy for voltage	0.1 %
Measuring accuracy for current	0.1 %
Measurement accuracy for active energy (kWh, .../5 A)	Class 0.2S
Number of digital inputs	2
Number of digital outputs	2
Number of pulse outputs	2
Current-measuring channels	4 + 2
Temperature input	Yes
Memory; minimum and maximum values	Yes
Memory size	256 MB
Interface	RS485: 9.6 - 921.6 kbps, Profibus DP, Ethernet, Web server/e-mail
Protocol	Modbus RTU, Modbus-Gateway, Modbus TCP/IP, Modbus RTU over Ethernet, SNMP, Profibus DP V0, BACnet (optional)

## Note

## Ordering data

Type	Qty.	Order No.
ENERGY ANALYSER 750-24	1	2534160000

## Note

## Accessories

DIN rail adapters  
Seal

	Qty.	Order No.
ENERGY METER BRACKET B1	1	2433040000
ENERGY METER SEAL L144	1	2495630000

Measurement range, voltage L-N, AC	347 V
Measurement range, voltage L-L, AC	600 V
Surge voltage category	600 V CAT III
Voltage supply	95 - 240 V AC, 80 - 300 V DC
Three-wire system	Yes
Four-wire system	Yes
Quadrants	4
Sampling frequency 50/60 Hz	25.6 kHz
Continuous measurements	Yes
Effective value from the period (50/60 Hz)	10 / 12
Measurement result per second	5
Residual current measuring	Yes
Harmonics, per order / voltage	1-63.
Harmonics, per order / current	1-63.
Unbalanced	Yes
Positive, negative and zero system	Yes
Measuring accuracy for voltage	0.1 %
Measuring accuracy for current	0.1 %
Measurement accuracy for active energy (kWh, .../5 A)	Class 0.2S
Number of digital inputs	2
Number of digital outputs	2
Number of pulse outputs	2
Current-measuring channels	4 + 2
Temperature input	Yes
Memory; minimum and maximum values	Yes
Memory size	256 MB
Interface	RS485: 9.6 - 921.6 kbps, Ethernet, Profibus DP, Web server/e-mail

Modbus RTU, Modbus-Gateway, Modbus TCP/IP, Modbus RTU over Ethernet, SNMP, Profibus DP V0, BACnet (optional)

Type	Qty.	Order No.
ENERGY ANALYSER 750-230	1	2534130000

	Qty.	Order No.
ENERGY METER BRACKET B1	1	2433040000
ENERGY METER SEAL L144	1	2495630000

## Note



## Provide measurement data efficiently and conveniently

### Our energy logger collects consumption and process data



#### Integrated temperature measurement

The Energy Logger D550 has an input for temperature measurement. This saves costs in setting up an infrastructure for the measurement of process parameters

#### Integrated ModBus interface

As well as the consumption data of simple measuring devices, measurement values from devices with a ModBus interface can also be forwarded over a network.

#### Integrated data memory

Data can be saved long-term in the device's built-in 32 MB memory.

As well as the consumption of electrical energy, the consumption of, for example, compressed air, water and gas can also be optimised. Energy Logger D550 enables the provision of cross-plant measurement data in the network.

Measuring devices with a simple S0 interface are widespread. But they cannot transfer measured values direct into the internal network. Therefore, a gateway is required for each measuring device. The Energy Logger D550 can collect and save impulse signals from up to 15 measurement devices and forwards them via a LAN interface.

This particularly compact Energy Logger D550 is the cost-effective solution to simplify and accelerate the collecting and forwarding of consumption and process data.

Energy Logger

Energy Logger D550



Technical data

Surge voltage category
Voltage supply
Operating-hours counter
Number of digital inputs
Number of digital outputs
Memory size
Software
<b>Interfaces</b>
Interface
<b>Protocol</b>
Protocol
<b>Note</b>

300 V CAT III
20 - 250 V AC, 20 - 300 V DC20 - 300 V DC
Yes
15
3
32 MB
ecoExplorer go®
RS485: 9,6 - 115,2 kbps, Ethernet
Modbus RTU, Modbus-Gateway, Modbus TCP/IP, Modbus RTU over Ethernet, SNMP
<b>Note</b>

Ordering data

<b>Note</b>
-------------

Type	Qty.	Order No.
ENERGY LOGGER D550	1	2425520000

Accessories

SO module 1.3 kOhm
--------------------

	Qty.	Order No.
ENERGY LOGGER SO MODULE	1	2446170000

<b>Note</b>
-------------

<b>Note</b>
-------------

## Create the data basis for consistent energy management

### u-sense vibration to connect your production to the IIoT

The IIoT makes it possible to network all components in a production facility with each other. This allows complete access to the exact status information of all components. The information can be used to minimise downtimes and reduce costs for monitoring and maintenance. The data can also be used to create the basis for consistent energy management.

Especially in existing facilities, many components do not yet have the necessary sensors for data collection and transmission. u-sense smart sensors, such as Weidmüller's u-sense vibration, can be retrofitted in all common industrial

facilities and connect the components to the IIoT. The sensors are particularly suitable for retrofitting electromechanical devices such as low-voltage motors, gears, pumps, fans, etc. As a result, the digitalisation of the entire production process can be implemented with very little effort. The data collected by u-sense vibration is sent via Bluetooth Low Energy (BLE) to a gateway, which prepares the data and transmits it directly to the cloud or to an on-site server. The data can then be accessed at any time. The clearly arranged dashboard provides a compact overview of the recorded machine data.



## Quick and easy integration - ideal for retrofitting

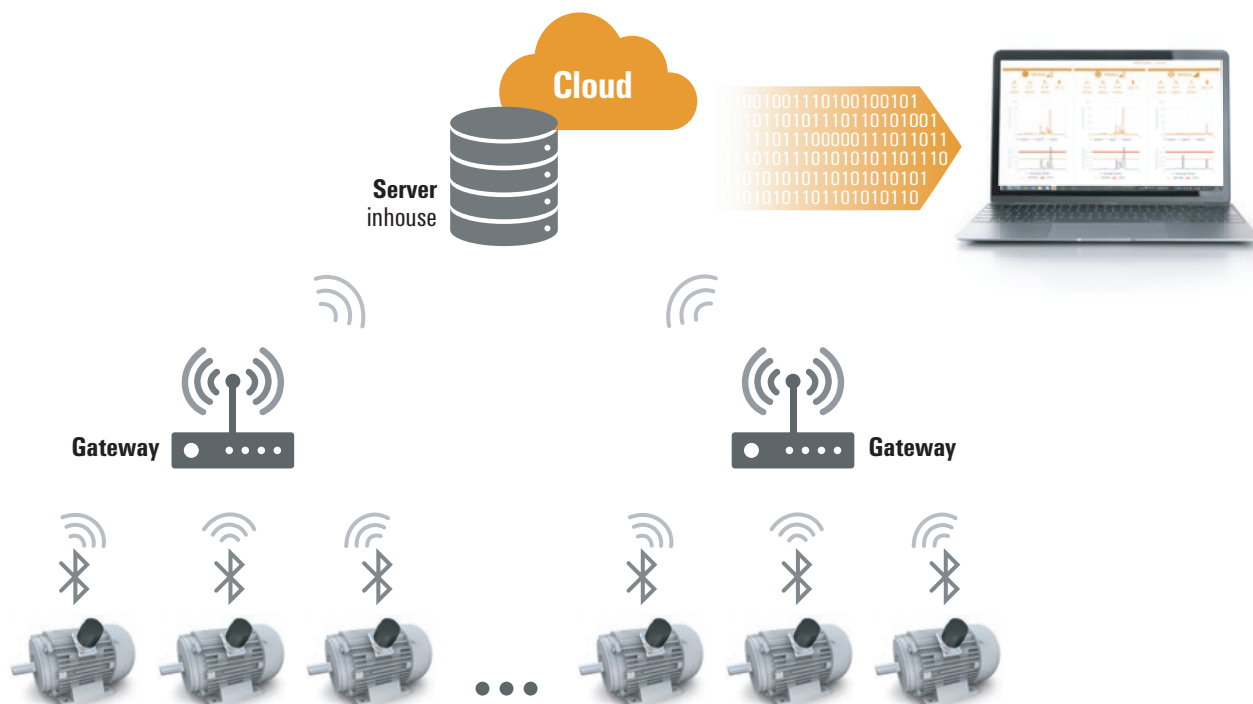

u-sense vibration can be easily integrated into existing systems. These systems can then be used to transfer data such as vibration or temperature measurement data to a server or to the cloud. Several mounting plates are available to allow for installation on an extremely wide range of different surfaces. u-sense vibration is optimally suited for industrial use thanks to its robust design, and is also approved for EX areas due to its IP67-protected housing.

Holistic production monitoring can be implemented by installing multiple u-sense vibration sensors on a production line. Once u-sense vibration has collected the data, it is forwarded to a gateway. This is where the data is prepared in order to ensure optimal data transfer. It is then sent to a previously designated server or cloud. The data can then be accessed at any time.

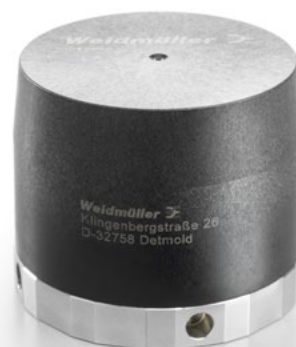

**You can find more information about the product on our website**

## u-sense energy drives - monitoring of IIoT drives

### Electrical motor data collection and transmission

Connection of simple asynchronous motors with the IIoT u-sense energy drives is an industrial solution for the provision of electrical data.

It can be easily integrated into existing systems and takes all electric motor connection variants into account. The integrated pre-processing unit provides all important data about the connected motor, such as the status, switching cycles, starting behaviour, rated current and voltage, active and reactive power, deviation between phases and much more.

In combination with analysis software, errors can be automatically identified and appropriate measures recommended.

IIoT integration is implemented via Modbus. The visualisation and data conversion to OPC UA is carried out by Weidmüller u-control. This allows the measured values to be displayed and used via PC, smartphone or tablet, regardless of location.

#### Advantages

- Particularly easy integration into existing infrastructures
- IP65-protected housing
- PUSH IN connection system



**Retrofit solution - easy to connect**

Integration into existing power lines, short downtime

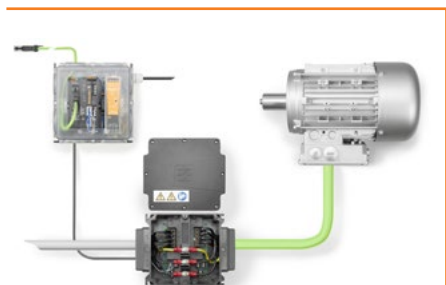

**Additional functionalities**

Flexible integration into existing drive infrastructure with star-delta switch connection, hybrid cable connection. Additional information via integrated analogue and digital inputs for external sensors.

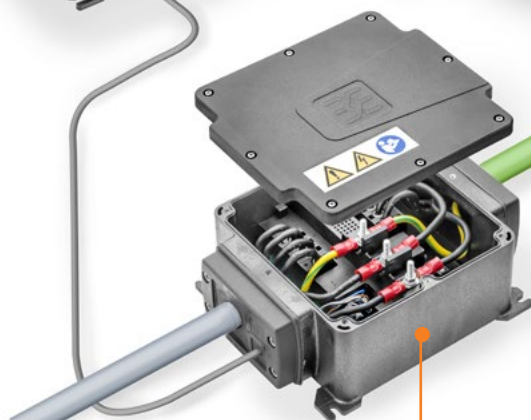
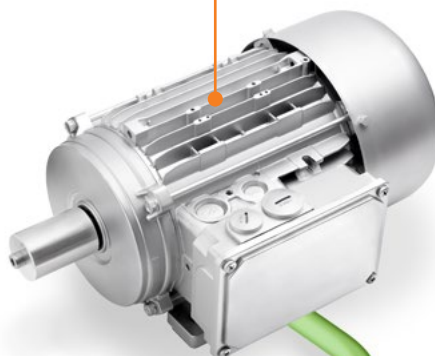
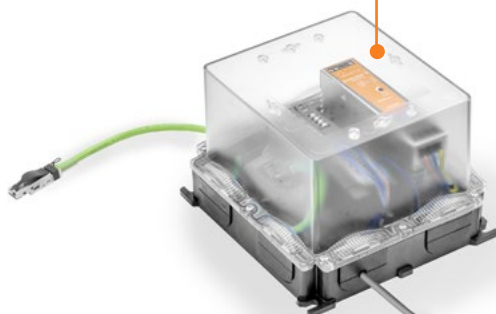
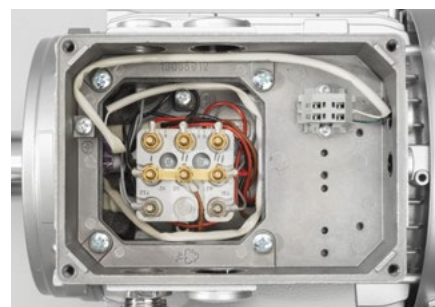

**Data pre-processing - data to information**

Reduce the data volume in cloud systems thanks to pre-processing on the sensor device. Communication via Modbus RTU.

**Industrial robustness - ready for tough environments**

Integration in industrial environments thanks to IP 65 protection class, vibration-proof modern PUSH IN connection technology and robust bolt technology



More information on our website

## Simple extension of measurement structures

### Industrial data acquisition with the IoT-terminal

Current transformers, digital flow meters and temperature sensors can measure various parameters in your machines and systems. While the energy meter collects data, the IoT-terminal acts as Modbus RTU master. Further values, whether digital or analogue, can also be recorded. This allows for the cost-effective extension of existing measurement structures with an IoT function. The application is particularly suitable for retrofitting existing machines and industrial facilities.

#### The particular benefits:

- Easy-to-integrate retrofit solution
- Compact designs
- Cloud integration via MQTT
- Mobile communication with NB-IoT and LTE-M Cat. 1
- Suitable for various applications



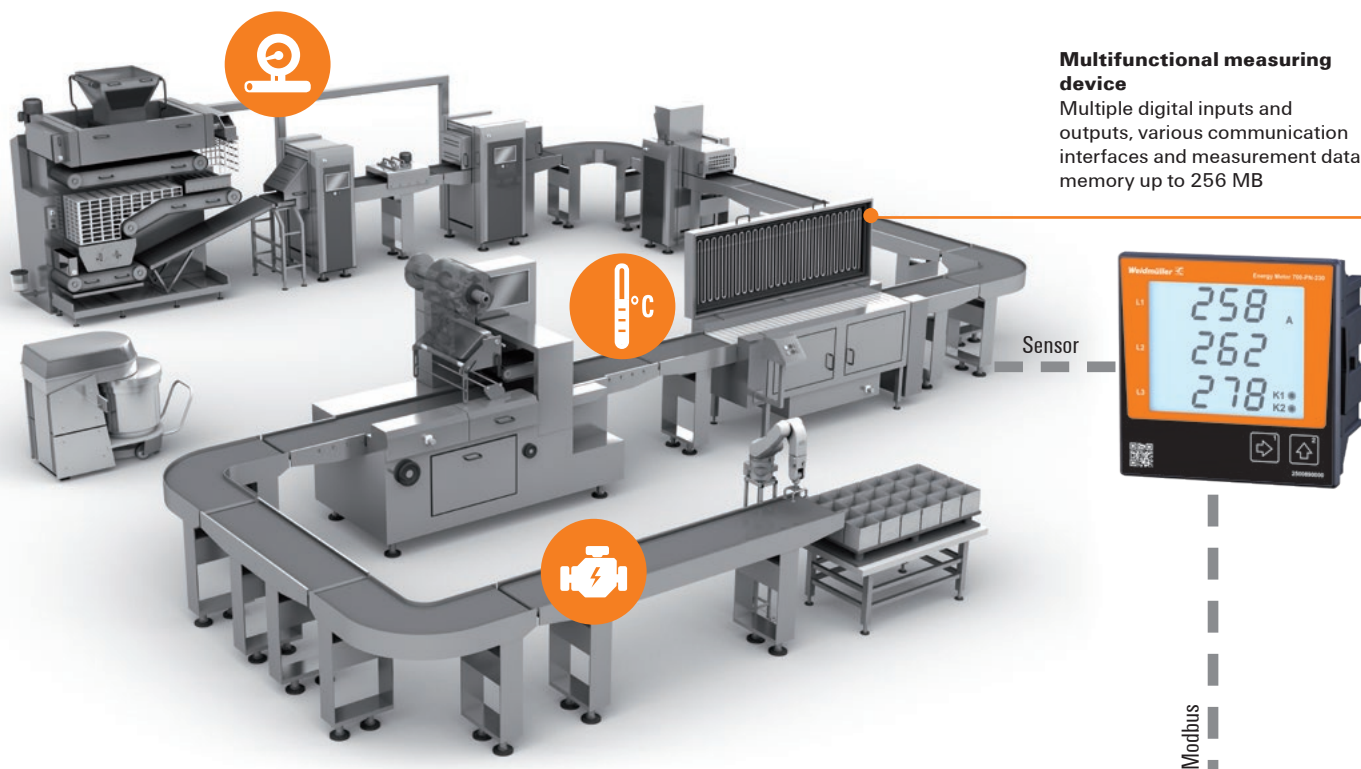

**Multifunctional measuring device**

Multiple digital inputs and outputs, various communication interfaces and measurement data memory up to 256 MB

**Cloud integration**

Communication to the Weidmüller cloud platform is performed via MQTT.

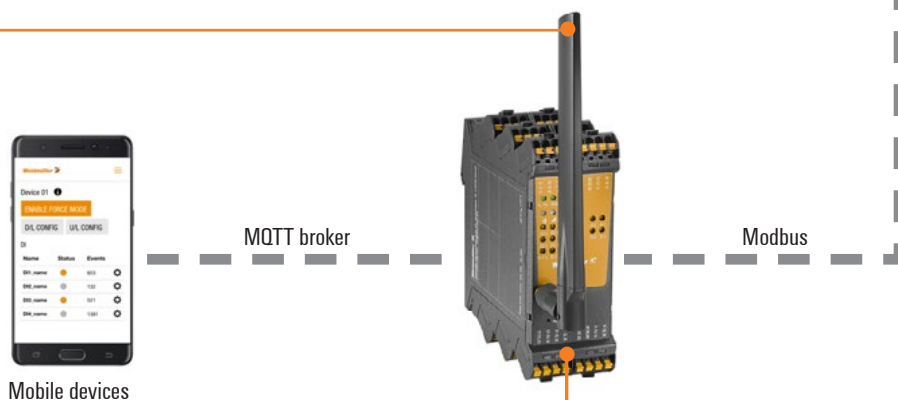

Mobile devices

**Mobile communication**

The data is communicated via NB-IoT and LTE-M Cat.1 mobile radio. These are 3GPP telecommunications standards that are optimised for cost-effective, energy-saving, low-rate and high-density IoT services.



**IoT-terminal**

**IoT-terminal**

- Retrofitting of Industrial IoT for existing systems
- Proven IT technologies, cost-optimal design
- Monitoring of spatially-separated systems with IoT solutions
- Integration of all system parts in automation
- Optimised for a wide range of industrial applications

**IT20-ATDIORO-NB-P**

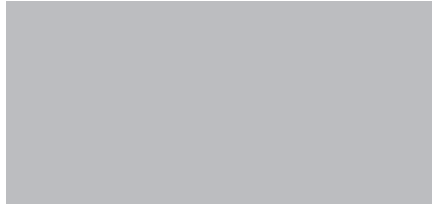
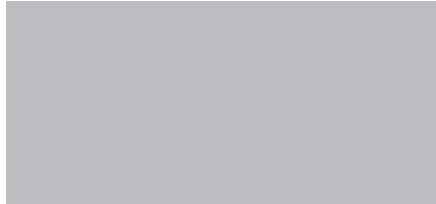

**Technical data**

<b>Supply</b>
Supply voltage at DC, min.
Supply voltage at DC, max.
<b>Communication</b>
Wireless module
SIM-Card slot type
<b>Input</b>
Number of channels analogue input - RTD
Sensor connection analogue input - RTD
Type analogue input - RTD
Number of channels analogue input - TC
Sensor connection analogue input - TC
Type analogue input - TC
Number of channels analogue input - V   mA
Sensor connection analogue input - V   mA
Resolution analogue input voltage - V   mA
Number of channels digital input
Sensor connection digital input
Input delay adjustable
RS-485 2-wire
<b>Output</b>
Number of channels digital output
Type
Number of channels relay output

9.6 V
31.2 V
Cat-M1, Cat-NB1, EDGE, GPRS
NANO-SIM
4
2-wire, 3-wire, 4-wire
Pt100, Pt200, Pt500, Pt1000, Ni100, Ni120, Ni 200, Ni500, Ni1000, Cu10, 40Ω, 80Ω, 150Ω, 300Ω, 500Ω, 1kΩ, 2kΩ, 4kΩ
4
2-wire
J, K, T, B, N, E, R, S, L, U, mV
2
2-wire
16 Bit
4
2-wire
0s...40s
Data+, Data-, GND
4
P-switching
2

**Note**

**Ordering data**

--

Type	Qty.	Order No.
IT20-ATDIORO-NB-P		2740080000

**Note**

**Accessories**

**Note**



# Compatibility for different measurement environments

## Current transformers from Weidmüller



Current transformers are used whenever currents cannot be measured directly. They are a special form of transformer that transforms the primary current into a (usually) smaller, standardised secondary current with a particular degree of accuracy (class), and galvanically separates the primary and secondary circuits from each other. The saturation of the core material due to physical factors gives the secondary circuit additional protection against strong currents. A fundamental distinction can be made between single-turn and coil transformers. The most common form of single-turn transformer is the plug-on current transformer. This is placed on the electrical cable, making it a transformer with a primary coil or secondary coils depending on the relevant translation.

### Translation ratio

The measurement translation is the ratio between the primary rated current and the secondary rated current, and is shown on the specification plate as a non-reduced fraction.  $x / 5$  A transformers are most frequently used because most measuring instruments have the higher class of accuracy with 5 A.  $x / 1$  A transformers are recommended for long measurement cables for technical and above all for cost reasons. The line losses of 1 A transformers are only 4% compared to 5 A transformers. In this case, however, the measuring instruments are less precise.

### Rated current

The rated (formerly: nominal) current is the figure for the primary and secondary current as stated on the specification plate (primary rated current, secondary rated current) for which the current transformer is rated. With the exception of classes 0.2 S and 0.5 S, the standardised rated currents are 10, 12.5, 15, 20, 25, 30, 40, 50, 60 and 75 A as well as decimal multiples and fractions thereof. The standardised secondary currents are 1 and 5 A.

### Overview of current converters



Type	Plug-on current transformer	Rod current transformer
<b>Technical information</b>		
Application	New systems	New systems
Coil	Closed	Closed
Installation	Round cable, copper busbar, terminal rail, mounting plate	Round cable (insulated)
Primary current	60 A...2,500 A	32 A...64 A
Secondary current	5 A	1 A
Accuracy class	0.5 oder 1	1
Ambient temperature	-5...+50 °C	-5...+50 °C
Standards	EN 61869-2	IEC 61869-2

Selecting the correct primary rated current is important for the accuracy of measurements. A ratio that is directly above the measured or defined current ( $I_n$ ) is recommended – for example:  $I_n = 1.154 \text{ A}$ , chosen transformer ratio = 1.250/5.

The rated current can also be defined based on the following considerations:

- Transformer rated current multiplied by approx. 1.1 (nearest transformer value)
- The fuse rated current (transformer rated current) of the measured sub-system (low-voltage distribution system, sub-distributor)
- Actual rated current multiplied by 1.2 (recommended in case the actual current is much lower than the transformer value or fuse rated current)

An overly large current transformer is to be avoided as otherwise the accuracy of measurements is significantly reduced in some cases for relatively small currents (in relation to the primary rated current).

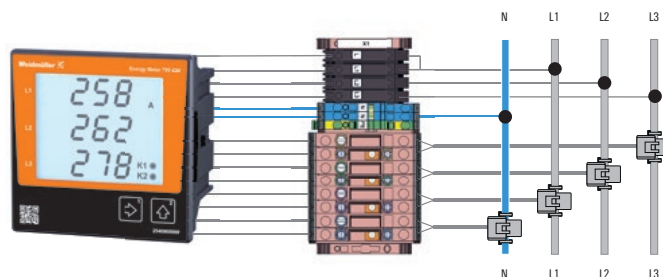

Split-core current transformer	RCM current transformers	System with Rogowski coil and analysis unit
Retrofitting	New systems/Retrofitting	Retrofitting
Detachable	Closed/Detachable	Detachable with bayonet joint
Round cable (insulated), copper busbar	Round cable, copper busbar	Round cable, copper busbar
50 A...5,000 A	18 A...25 A	5,000 A
1 A or 5 A	0.0417 A	1 A
0.5; 1 or 3		0.5/0.5
-5...+55 °C	-10 °C...+70 °C	-40...+80 °C
EN 61869-2	EN 61869-2	IEC 61010 / EN 61869-2

Plug-on current transformer

The CMA-31 series current transformer registers primary currents of 60 A to 2.500 A and transforms these into up to 5 A on the secondary side. The transformer is equipped with a maintenance-free, spring-balanced cage clamp and is especially suitable for installation on current bars and cables of new systems.



Ordering data

Order No.	Type	Primary current	Secondary current max.	Tolerance class	Load	Round conductor	Rail	Qty.
2421380000	CMA-31-60-5A-1,25VA-1	60 A	5 A	1	1.25 VA	25.70 mm	20 x 20 mm, 25 x 12 mm, 30 x 10 mm	1
1482040000	CMA-31-75-5A-2,5VA-1	75 A	5 A	1	2.5 VA	25.70 mm	20 x 20 mm, 25 x 12 mm, 30 x 10 mm	1
1482030000	CMA-31-100-5A-2,5VA-1	100 A	5 A	1	2.5 VA	25.70 mm	20 x 20 mm, 25 x 12 mm, 30 x 10 mm	1
2420960000	CMA-31-150-5A-5VA-1	150 A	5 A	1	5 VA	25.70 mm	20 x 20 mm, 25 x 12 mm, 30 x 10 mm	1
2420950000	CMA-31-200-5A-5VA-1	200 A	5 A	1	5 VA	25.70 mm	20 x 20 mm, 25 x 12 mm, 30 x 10 mm	1
2420940000	CMA-31-250-5A-5VA-1	250 A	5 A	1	5 VA	25.70 mm	20 x 20 mm, 25 x 12 mm, 30 x 10 mm	1
2420920000	CMA-31-400-5A-5VA-1	400 A	5 A	1	5 VA	25.70 mm	20 x 20 mm, 25 x 12 mm, 30 x 10 mm	1
2420910000	CMA-31-500-5A-5VA-1	500 A	5 A	1	5 VA	25.70 mm	20 x 20 mm, 25 x 12 mm, 30 x 10 mm	1
2420900000	CMA-31-600-5A-5VA-1	600 A	5 A	1	5 VA	25.70 mm	20 x 20 mm, 25 x 12 mm, 30 x 10 mm	1
2420890000	CMA-31-750-5A-5VA-1	750 A	5 A	1	5 VA	25.70 mm	20 x 20 mm, 25 x 12 mm, 30 x 10 mm	1
2680150000	CMA-41-1000-5A-5VA-1	1000 A	5 A	1	5 VA	31.00 mm	30 x 15 mm, 40 x 10 mm	1
2680160000	CMA-51-1250-5A-5VA-1	1250 A	5 A	1	5 VA	43.00 mm	40 x 30 mm, 50 x 12 mm	1
2680170000	CMA-61-1500-5A-5VA-1	1500 A	5 A	1	5 VA	43.00 mm	50 x 30 mm, 63 x 10 mm	1
2680180000	CMA-81-2000-5A-10VA-1	2000 A	5 A	1	10 VA	54.00 mm	80 x 10 mm, 60 x 30 mm	1
2680190000	CMA-101-2500-5A-10VA-1	2500 A	5 A	1	10 VA	70.00 mm	100 x 10 mm, 80 x 30 mm	1
2680200000	CMA-31-125-5A-2,5VA-0,5	125 A	5 A	0,5	2.5 VA	25.70 mm	30 x 10 mm, 25 x 12 mm, 20 x 20 mm	1
2421030000	CMA-31-150-5A-2,5VA-0,5	150 A	5 A	0,5	2.5 VA	25.70 mm	20 x 20 mm, 25 x 12 mm, 30 x 10 mm	1
2421020000	CMA-31-200-5A-2,5VA-0,5	200 A	5 A	0,5	2.5 VA	25.70 mm	20 x 20 mm, 25 x 12 mm, 30 x 10 mm	1
1482050000	CMA-31-250-5A-5VA-0,5	250 A	5 A	0,5	5 VA	25.70 mm	20 x 20 mm, 25 x 12 mm, 30 x 10 mm	1
2420990000	CMA-31-300-5A-5VA-0,5	300 A	5 A	0,5	5 VA	25.70 mm	20 x 20 mm, 25 x 12 mm, 30 x 10 mm	1
2420980000	CMA-31-400-5A-5VA-0,5	400 A	5 A	0,5	5 VA	25.70 mm	20 x 20 mm, 25 x 12 mm, 30 x 10 mm	1
1482070000	CMA-31-500-5A-5VA-0,5	500 A	5 A	0,5	5 VA	25.70 mm	20 x 20 mm, 25 x 12 mm, 30 x 10 mm	1
2420970000	CMA-31-600-5A-5VA-0,5	600 A	5 A	0,5	5 VA	25.70 mm	20 x 20 mm, 25 x 12 mm, 30 x 10 mm	1
1482080000	CMA-31-750-5A-5VA-0,5	750 A	5 A	0,5	5 VA	25.70 mm	20 x 20 mm, 25 x 12 mm, 30 x 10 mm	1
2680210000	CMA-41-1000-5A-5VA-0,5	1000 A	5 A	0,5	5 VA	31.00 mm	30 x 15 mm, 40 x 10 mm	1
2680220000	CMA-51-1250-5A-5VA-0,5	1250 A	5 A	0,5	5 VA	43.00 mm	50 x 12 mm, 40 x 30 mm	1
2680230000	CMA-61-1500-5A-5VA-0,5	1500 A	5 A	0,5	5 VA	43.00 mm	50 x 30 mm, 63 x 10 mm	1
2680240000	CMA-81-2000-5A-10VA-0,5	2000 A	5 A	0,5	10 VA	54.00 mm	60 x 30 mm, 80 x 10 mm	1
2680250000	CMA-101-2500-5A-10VA-0,5	2500 A	5 A	0,5	10 VA	70.00 mm	100 x 10 mm, 80 x 30 mm	1
<b>Note</b>	For additional articles and information, refer to <a href="http://catalog.weidmueller.com">catalog.weidmueller.com</a>							

CMA-31

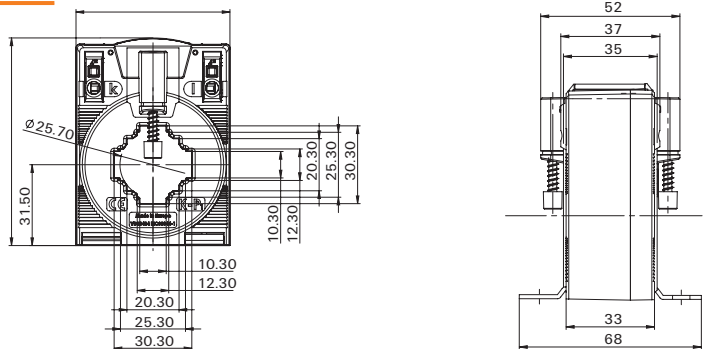

CMA-41

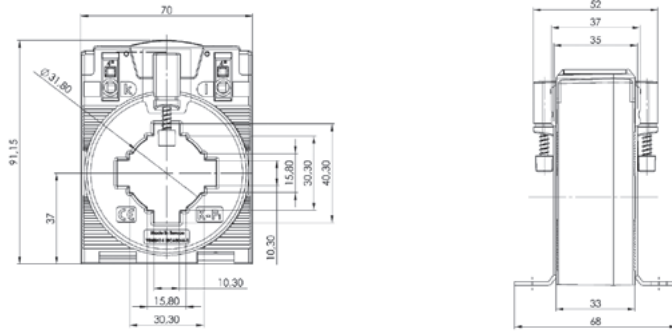

CMA-51

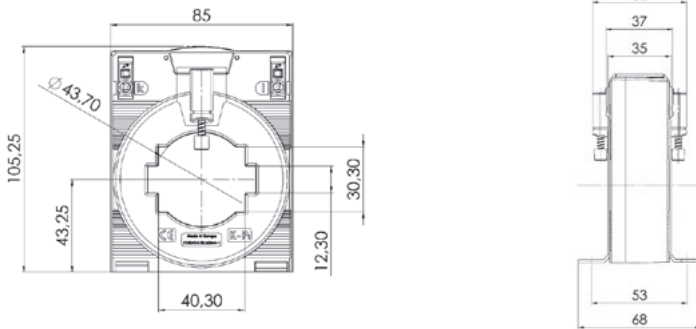

CMA-61

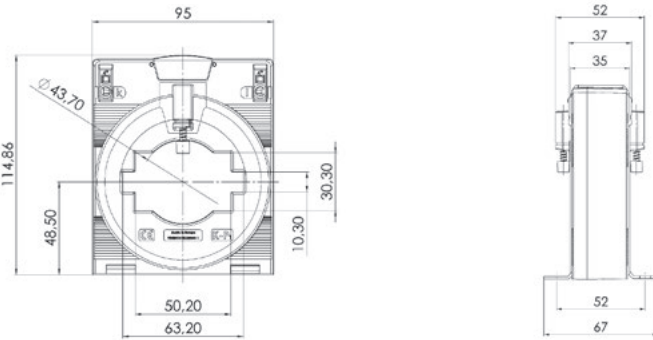

CMA-81

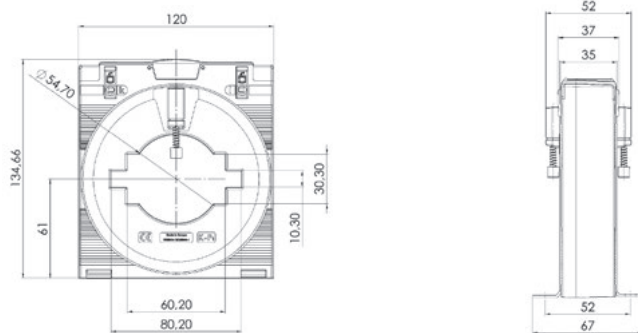

CMA-101

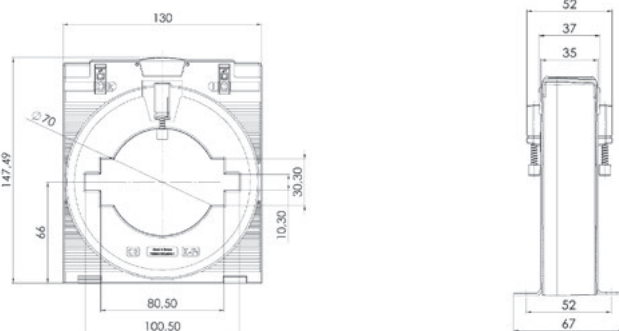

## Current transformer

The CMA-CTM 7 series mini current transformer is an inductive current transformer designed according to the transformer principle for circular primary conductors. The CMA-CTM 7 series current transformers are maintenance-free and are designed for primary currents of 32 A to 64 A. These are transformed into a current of up to 1 A on the secondary side.

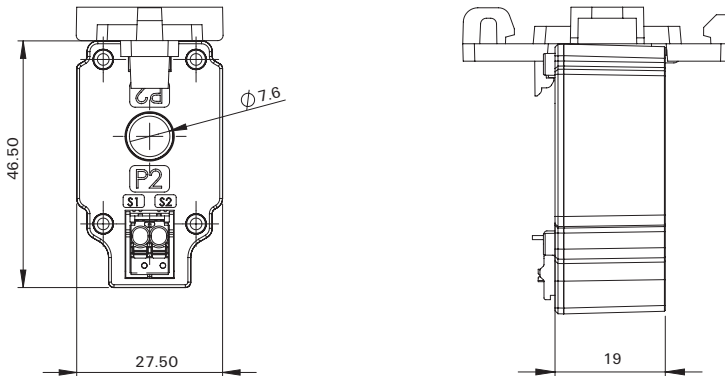

### Ordering data

Order No.	Type	Primary current	Secondary current max.	Tolerance class	Load	Round conductor	Qty.
2525150000	CMA-CTM-7-32-1A-0.2VA-1	32 A	1 A	1	0.2 VA	7.60 mm	1
2556030000	CMA-CTM-7-50-1A-0.4VA-1	50 A	1 A	1	0.4 VA	7.60 mm	1
2556010000	CMA-CTM-7-64-1A-0.5VA-1	64 A	1 A	1	0.5 VA	7.60 mm	1

#### Note

### Cable-type current transformer

The KCMA series cable-type current transformer is mainly used for retrofitting in existing systems. Due to its compact design with dimensions of 41.6 mm x 64.5 mm x 68 mm, it is especially suited for installation in hard-to-reach places or use in locations with restricted dimensional freedom. The KCMA-18 registers primary currents of 50 A to 250 A and transforms these into up to 5 A on the secondary side. To install the transformer, the locking mechanism is opened, the transformer is positioned around the primary conductor and is then closed again with an audible click. Once the secondary cables are successfully connected, the measuring apparatus is immediately ready for operation.

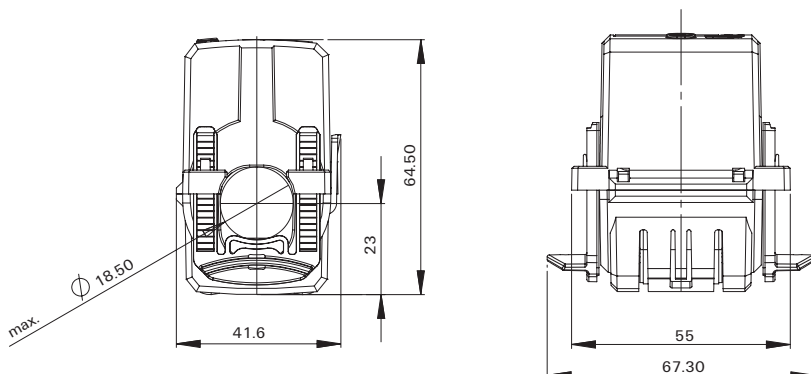

### Ordering data

Order No.	Type	Primary current	Secondary current max.	Tolerance class	Load	Round conductor	Qty.
1482020000	KCMA-18-50-1A-1VA-3	50 A	1 A	3	1 VA	18.50 mm	1
2420780000	KCMA-18-75-1A-1VA-3	75 A	1 A	3	1 VA	18.50 mm	1
1482010000	KCMA-18-100-1A-1,25VA-3	100 A	1 A	3	1.25 VA	18.50 mm	1
2752980000	KCMA-18-125-1A-1,5VA-3	125 A	1 A	3	1.5 VA	18.50 mm	1
2420770000	KCMA-18-150-1A-2VA-3	150 A	1 A	3	2 VA	18.50 mm	1
2420760000	KCMA-18-200-1A-3VA-3	200 A	1 A	3	3 VA	18.50 mm	1
2420750000	KCMA-18-250-1A-4VA-3	250 A	1 A	3	4 VA	18.50 mm	1
2752990000	KCMA-18-100-1A-0.3VA-1	100 A	1 A	1	0.3 VA	18.50 mm	1
2753000000	KCMA-18-125-1A-0.5VA-1	125 A	1 A	1	0.5 VA	18.50 mm	1
2753010000	KCMA-18-150-1A-1VA-1	150 A	1 A	1	1 VA	18.50 mm	1
2753020000	KCMA-18-200-1A-1.5VA-1	200 A	1 A	1	1.5 VA	18.50 mm	1
1482000000	KCMA-18-250-1A-1.5VA-1	250 A	1 A	1	1.5 VA	18.50 mm	1
2753030000	KCMA-18-150-5A-1VA-1	150 A	5 A	1	1 VA	18.50 mm	1
2753040000	KCMA-18-200-5A-1.5VA-1	200 A	5 A	1	1.5 VA	18.50 mm	1
2753050000	KCMA-18-250-5A-1VA-0.5	250 A	5 A	0,5	1 VA	18.50 mm	1

Note

**Cable-type current transformer**

The KCMA-28 series cable-type current transformer is mainly used for retrofitting in existing systems. Due to its compact design with dimensions of 49 mm x 59 mm x 79.5 mm, it is especially suited for installation in hard-to-reach places or use in locations with restricted dimensional freedom. The KCMA-28 registers primary currents of 200 A to 500 A and transforms these into up to 5 A on the secondary side. To install the transformer, the locking mechanism is opened, the transformer is positioned around the primary conductor and is then closed again with an audible click. Once the secondary cables are successfully connected, the measuring apparatus is immediately ready for operation.

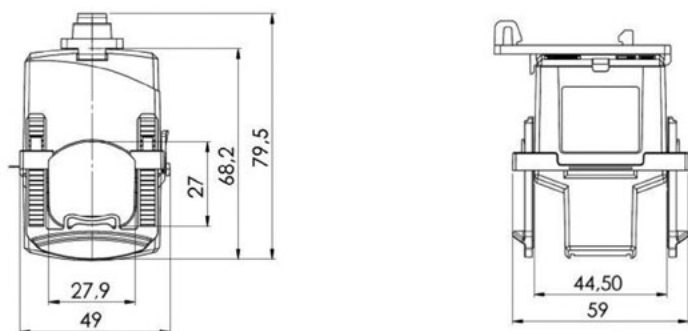

**Ordering data**

Order No.	Type	Primary current	Secondary current max.	Tolerance class	Load	Round conductor	Qty.
2753060000	KCMA-28-200-1A-0.3VA-1	200 A	1 A	1	0.3 VA	27.00 mm	1
2753070000	KCMA-28-250-1A-1VA-1	250 A	1 A	1	1 VA	27.00 mm	1
2753080000	KCMA-28-300-1A-1.5VA-1	300 A	1 A	1	1.5 VA	27.00 mm	1
2753090000	KCMA-28-400-1A-2.5VA-1	400 A	1 A	1	2.5 VA	27.00 mm	1
2753100000	KCMA-28-500-1A-1VA-0.5	500 A	1 A	0,5	1 VA	27.00 mm	1
2753110000	KCMA-28-250-5A-1VA-1	250 A	5 A	1	1 VA	27.00 mm	1
2753120000	KCMA-28-300-5A-1.5VA-1	300 A	5 A	1	1.5 VA	27.00 mm	1
2753130000	KCMA-28-400-5A-2.5VA-1	400 A	5 A	1	2.5 VA	27.00 mm	1
2753140000	KCMA-28-500-5A-3VA-1	500 A	5 A	1	3 VA	27.00 mm	1

Note

### Cable-type current transformer

The KCMA-32 series cable-type current transformer is mainly used for retrofitting in existing systems. Due to its compact design with dimensions of 59.2 mm x 96.4 mm x 90 mm, it is especially suited for installation in hard-to-reach places or use in locations with restricted dimensional freedom. The KCMA-32 registers primary currents of 400 A to 600 A and transforms these into up to 5 A on the secondary side. To install the transformer, the locking mechanism is opened, the transformer is positioned around the primary conductor and is then closed again with an audible click. Once the secondary cables are successfully connected, the measuring apparatus is immediately ready for operation.

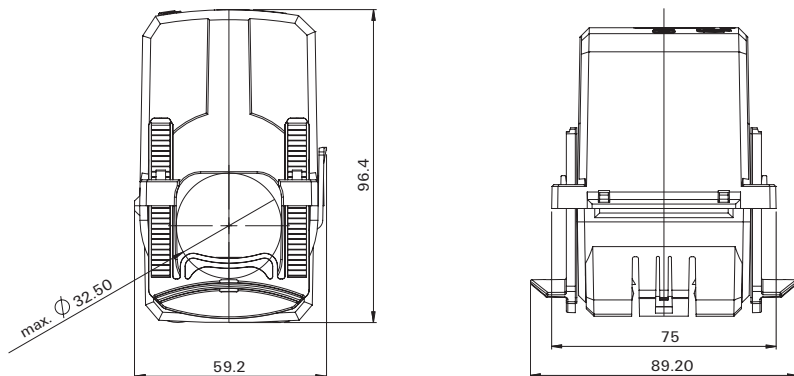

### Ordering data

Order No.	Type	Primary current	Secondary current max.	Tolerance class	Load	Round conductor	Qty.
1481990000	KCMA-32-400-1A-5VA-1	400 A	1 A	1	5 VA	32.50 mm	1
1481980000	KCMA-32-600-1A-5VA-1	600 A	1 A	1	5 VA	32.50 mm	1
2420730000	KCMA-32-400-5A-5VA-1	400 A	5 A	1	5 VA	32.50 mm	1
2420740000	KCMA-32-500-5A-5VA-1	500 A	5 A	1	5 VA	32.50 mm	1
2420720000	KCMA-32-600-5A-5VA-1	600 A	5 A	1	5 VA	32.50 mm	1

Note

**Cable-type current transformer**

The KCMA-42 series cable-type current transformer is mainly used for retrofitting in existing systems. As a result of its compact design with dimensions of 72.2 mm x 120.6 mm x 98.1 mm, it is especially suited for installation in hard-to-reach places or use in locations with restricted dimensional freedom. The KCMA-42 registers primary currents of 250 A to 1000 A and transforms these into up to 5 A on the secondary side. To install the transformer, the locking mechanism is opened, the transformer is positioned around the primary conductor and is then closed again with an audible click. Once the secondary cables are successfully connected, the measuring apparatus is immediately ready for operation.

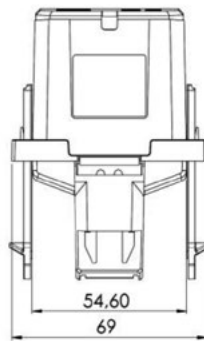
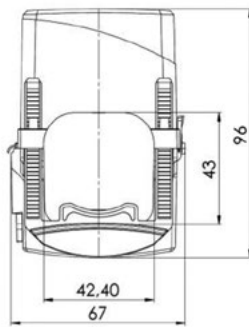

**Ordering data**

Order No.	Type	Primary current	Secondary current max.	Tolerance class	Load	Round conductor	Qty.
2753150000	KCMA-42-250-1A-2.5VA-1	250 A	1 A	1	2.5 VA	32.50 mm	1
2753160000	KCMA-42-300-1A-2.5VA-1	300 A	1 A	1	2.5 VA	32.50 mm	1
2753170000	KCMA-42-400-1A-2.5VA-0.5	400 A	1 A	0,5	2.5 VA	32.50 mm	1
2753180000	KCMA-42-500-1A-2.5VA-0.5	500 A	1 A	0,5	2.5 VA	32.50 mm	1
2753190000	KCMA-42-600-1A-2.5VA-0.5	600 A	1 A	0,5	2.5 VA	32.50 mm	1
2753200000	KCMA-42-750-1A-2.5VA-0.5	750 A	1 A	0,5	2.5 VA	32.50 mm	1
2753210000	KCMA-42-800-1A-2.5VA-0.5	800 A	1 A	0,5	2.5 VA	32.50 mm	1
2753220000	KCMA-42-1000-1A-2.5VA-0.5	1000 A	1 A	0,5	2.5 VA	32.50 mm	1
2753230000	KCMA-42-300-5A-2.5VA-1	300 A	5 A	1	2.5 VA	32.50 mm	1
2753240000	KCMA-42-400-5A-5VA-1	400 A	5 A	1	5 VA	32.50 mm	1
2753250000	KCMA-42-500-5A-5VA-1	500 A	5 A	1	5 VA	32.50 mm	1
2753260000	KCMA-42-600-5A-2.5VA-0.5	600 A	5 A	0,5	2.5 VA	32.50 mm	1
2753270000	KCMA-42-750-5A-2.5VA-0.5	750 A	5 A	0,5	2.5 VA	32.50 mm	1
2753280000	KCMA-42-800-5A-2.5VA-0.5	800 A	5 A	0,5	2.5 VA	32.50 mm	1
2753290000	KCMA-42-1000-5A-2.5VA-0.5	1000 A	5 A	0,5	2.5 VA	32.50 mm	1

Note

### Cable-type current transformer

The KCMA-44 series cable-type current transformer is mainly used for retrofitting in existing systems. As a result of its compact design with dimensions of 72.2 mm x 120.6 mm x 98 mm, it is especially suited for installation in hard-to-reach places or use in locations with restricted dimensional freedom. The KCMA-44 registers primary currents of 750 A to 1000 A and transforms these into up to 5 A on the secondary side. To install the transformer, the locking mechanism is opened, the transformer is positioned around the primary conductor and is then closed again with an audible click. Once the secondary cables are successfully connected, the measuring apparatus is immediately ready for operation.

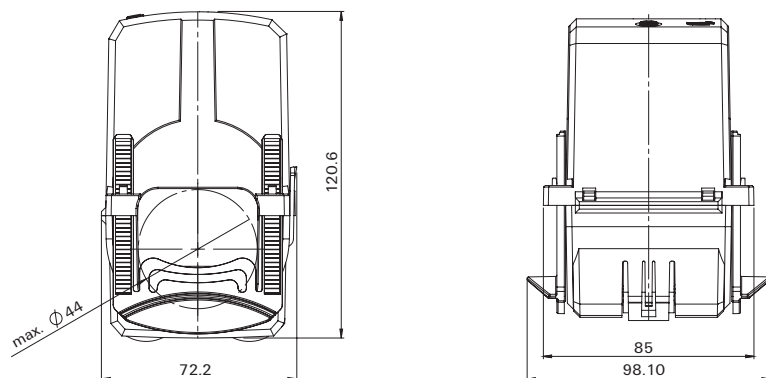

### Ordering data

Order No.	Type	Primary current	Secondary current max.	Tolerance class	Load	Round conductor	Qty.
2420710000	KCMA-44-750-5A-5VA-1	750 A	5 A	1	5 VA	44.00 mm	1
2437370000	KCMA-44-800-5A-5VA-1	800 A	5 A	1	5 VA	44.00 mm	1
2437400000	KCMA-44-1000-5A-5VA-1	1000 A	5 A	1	5 VA	44.00 mm	1

Note

## Current transformer

### Cable-type current transformer

The KCMA-5 series cable-type current transformer with its separable measuring core allows it to be retrofitted in existing systems without disconnecting the primary conductor. Thanks to the practical integrated interlock system, the transformer can be positioned around the primary conductor and then closed again with an audible click. The KCMA-5 registers primary currents of 250 A to 1000 A and transforms these into currents of up to 5 A on the secondary side.

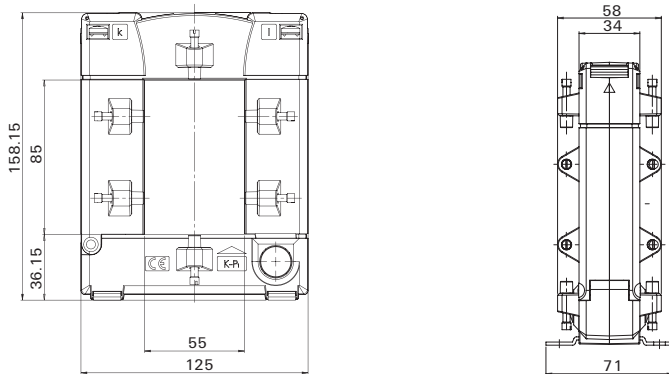
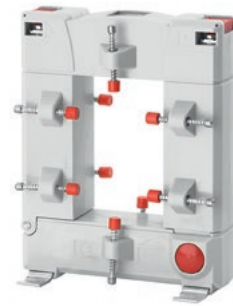

### Ordering data

Order No.	Type	Primary current	Secondary current max.	Tolerance class	Load	Round conductor	Rail	Qty.
2753360000	KCMA 5-250-5A-1.5VA-1	250 A	5 A	1	1.5 VA	55.00 mm	50 x 80 mm	1
2753370000	KCMA 5-400-5A-1VA-0.5	400 A	5 A	0,5	1 VA	55.00 mm	50 x 80 mm	1
2753380000	KCMA 5-500-5A-2.5VA-0.5	500 A	5 A	0,5	2.5 VA	55.00 mm	50 x 80 mm	1
2753390000	KCMA 5-600-5A-2.5VA-0.5	600 A	5 A	0,5	2.5 VA	55.00 mm	50 x 80 mm	1
2753400000	KCMA 5-1000-5A-5VA-0.5	1000 A	5 A	0,5	5 VA	55.00 mm	50 x 80 mm	1

Note

### Cable-type current transformer

The KCMA-8 series cable-type current transformer with its separable measuring core allows it to be retrofitted in existing systems without disconnecting the primary conductor. Thanks to the practical integrated interlock system, the transformer can be positioned around the primary conductor and then closed again with an audible click. The KCMA-8 registers primary currents of 250 A to 5000 A and transforms these into currents of up to 5 A on the secondary side.

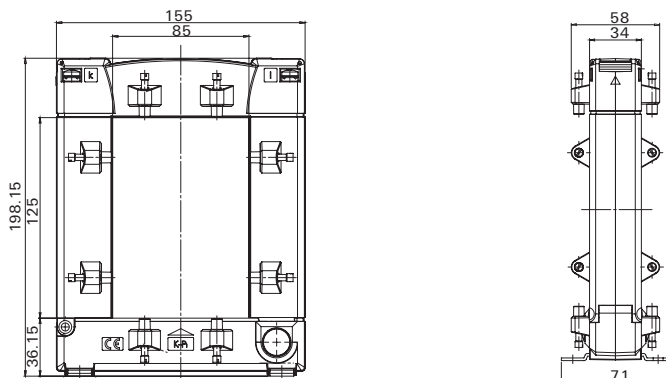
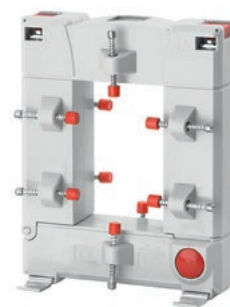

### Ordering data

Order No.	Type	Primary current	Secondary current max.	Tolerance class	Load	Round conductor	Rail	Qty.
2728090000	KCMA-8-250-5A-1.5VA1	250 A	5 A	1	1.5 VA	80.00 mm	80 x 120 mm	1
2728100000	KCMA-8-500-5A-5VA1	500 A	5 A	1	5 VA	80.00 mm	80 x 120 mm	1
2728110000	KCMA-8-750-5A-2VA1	750 A	5 A	1	2 VA	80.00 mm	80 x 120 mm	1
2728130000	KCMA-8-1000-5A-10VA1	1000 A	5 A	1	10 VA	80.00 mm	80 x 120 mm	1
2728140000	KCMA-8-1200-5A-10VA1	1200 A	5 A	1	10 VA	80.00 mm	80 x 120 mm	1
2728150000	KCMA-8-1500-5A-15VA1	1500 A	5 A	1	15 VA	80.00 mm	80 x 120 mm	1
2728160000	KCMA-8-2000-5A-15VA1	2000 A	5 A	1	15 VA	80.00 mm	80 x 120 mm	1
2728170000	KCMA-8-2500-5A-15VA1	2500 A	5 A	1	15 VA	80.00 mm	80 x 120 mm	1
2728180000	KCMA-8-3000-5A-15VA1	3000 A	5 A	1	15 VA	80.00 mm	80 x 120 mm	1
2728190000	KCMA-8-4000-5A-15VA1	4000 A	5 A	1	15 VA	80.00 mm	80 x 120 mm	1
2728210000	KCMA-8-5000-5A-15VA1	5000 A	5 A	1	15 VA	80.00 mm	80 x 120 mm	1
2753410000	KCMA-8-600-5A-2.5VA-0.5	600 A	5 A	0,5	2.5 VA	80.00 mm	80 x 120 mm	1
2753420000	KCMA-8-800-5A-2.5VA-0.5	800 A	5 A	0,5	2.5 VA	80.00 mm	80 x 120 mm	1
2753430000	KCMA-8-1000-5A-5VA-0.5	1000 A	5 A	0,5	5 VA	80.00 mm	80 x 120 mm	1
2753450000	KCMA-8-1200-5A-5VA-0.5	1200 A	5 A	0,5	5 VA	80.00 mm	80 x 120 mm	1

Note

## Current transformer

### Cable-type current transformer

The current transformers of the CMA-RCM series are current transformers for RCM measurement on circular primary conductors. Current transformers of this series are maintenance-free and designed for the detection of residual currents of 25 A.



### Ordering data

Order No.	Type	Primary current	Round conductor	Qty.
2603420000	CMA-RCM-DACT-20	25 A	20.00 mm	1
2603430000	CMA-RCM-DACT-35	25 A	35.00 mm	1
2603440000	CMA-RCM-DACT-60	25 A	60.00 mm	1
2603450000	CMA-RCM-DACT-120	25 A	120.00 mm	1
Note				

CMA-RCM-DACT-20

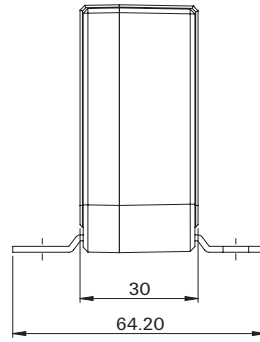
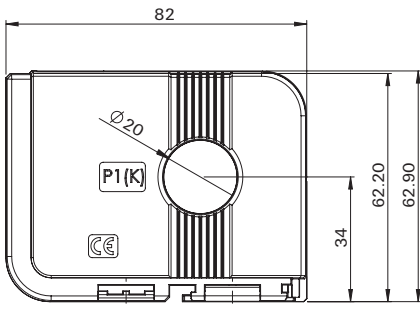

CMA-RCM-DACT-35

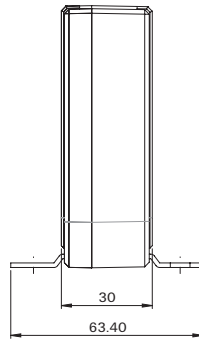
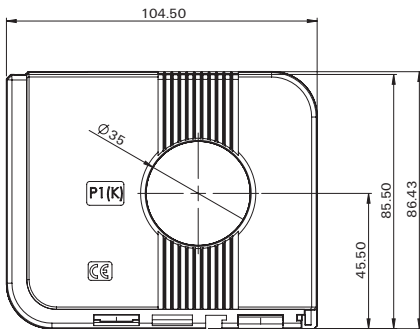

CMA-RCM-DACT-60

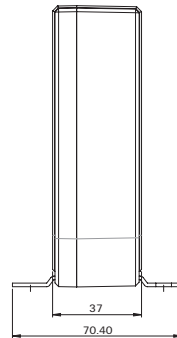
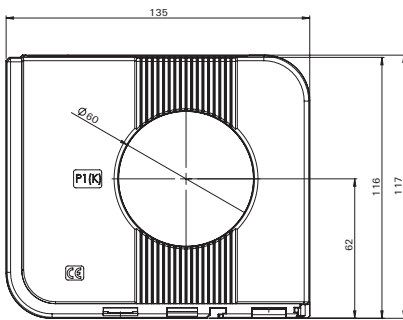

CMA-RCM-DACT-120

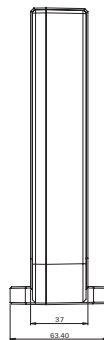
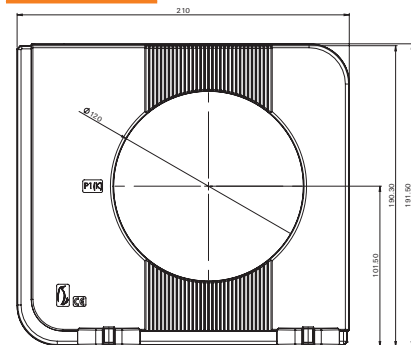

## Current transformer

### Cable-type current transformer

The KCMA-RCM series cable conversion current transformer is mainly used to retrofit an RCM measurement into existing systems. The KCMA-RCM measures residual currents of up to 18 A. During installation, the locking mechanism of the transformer is opened, the transformer is placed around the primary conductor and audibly re-engaged. After successful connection of the secondary conductors, the measurement setup is immediately ready for operation.

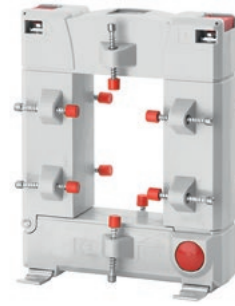

### Ordering data

Order No.	Type	Primary current	Round conductor	Qty.
2656270000	KCMA-RCM-23D	18 A	20.00 mm	1
2656280000	KCMA-RCM-58D	18 A	50.00 mm	1
2656290000	KCMA-RCM-812D	18 A	80.00 mm	1
Note				

KCMA-RCM-23D

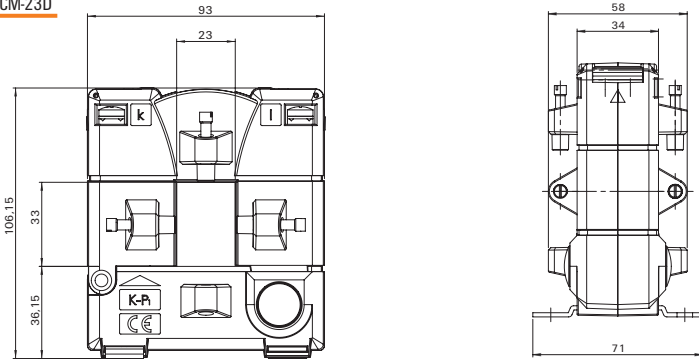

KCMA-RCM-58D

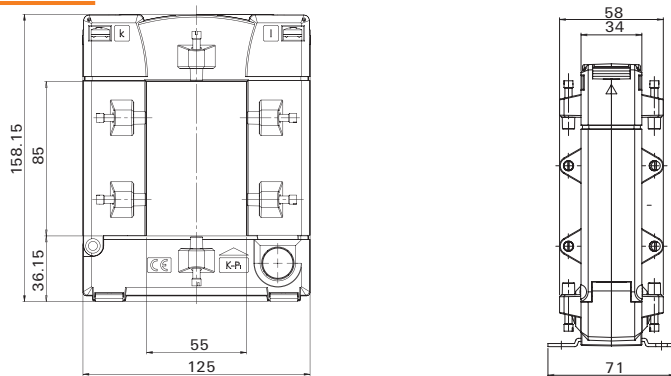

KCMA-RCM-812D

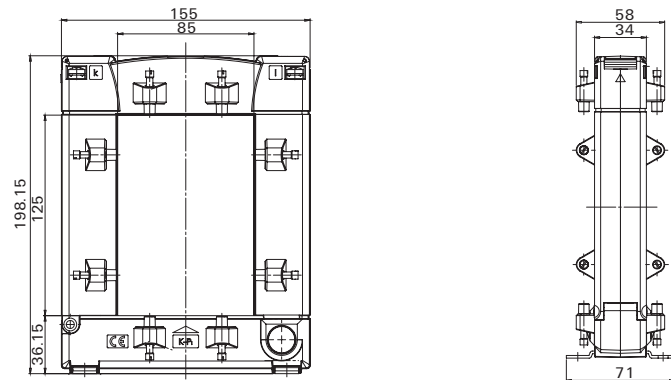

## Measure energy consumption simply, safely and flexibly

### Rogowski current transformer system for easy retrofitting

To comply with growing environmental demands, companies must provide transparency about the energy consumption of their machines and plants. Rogowski coils reliably measure alternating current and integrate quickly and easily into existing environments.

As well as conventional current transformers, Rogowski coils can also be used for current measurement. The fact that there is no iron core means that any non-linear influences of the iron core are eliminated. Rogowski coils can be easily applied and removed without disconnecting the circuit, i.e. without any major assembly work. In contrast to current transformers, high short-circuit currents in power distribution do not cause high losses in Rogowski coils. There is also no chance of any saturation or remanence effects that could be detrimental to the measurement. Likewise, no dangerous voltages can be generated in open operation.

Our Rogowski coils can be, optionally, integrated on busbars or with power cables. Three sizes are available to fit diameters between 70 and 175 mm. The output signal of a coil feeds to a transmitter, which detects alternating currents or a voltage signal. One of two models has a standard output signal (1 A), while the other allows to adjust the output signal to four different V or mA ranges. The input measuring range can be selected from twelve values between 100 and 5000 A.

#### Key features:

- Evaluation unit for Rogowski coils
- Linearity error below 0.1%
- Combined with our Rogowski coils, the unit offers a universal measuring and monitoring solution
- DIN installation
- 12 different current ranges available, from 100 to 5000 A
- Choice of different outputs (RCMC-5000-A0-P only):  
4 true RMS outputs: 0-20 mA, 4-20 mA, 0-5 V & 0-10 V  
and 2 undelayed voltage outputs: 0-225 mV and 0-333 mV or 1 A output
- Simple configuration with 2 buttons
- Visible two-colour status LED
- Operating temperature range -25 °C to +70 °C
- Supply voltage +24 V



Rogowski-System



Ordering data

Order No.	Type	Diameter	Cable length	Primary current	Qty.
<b>Rogowski coils</b>					
2593370000	RCMA-B22-D70-1.5	70 mm	1.5 m	5000 A	1
2593340000	RCMA-B22-D70-4.5	70 mm	4.5 m	5000 A	1
2593380000	RCMA-B22-D125-1.5	125 mm	1.5 m	5000 A	1
2593350000	RCMA-B22-D125-4.5	125 mm	4.5 m	5000 A	1
2593390000	RCMA-B22-D175-1.5	175 mm	1.5 m	5000 A	1
2593360000	RCMA-B22-D175-4.5	175 mm	4.5 m	5000 A	1
<b>Note</b>					



Ordering data

Order No	Type	Output current	Output voltage	Input measurement range	Qty.
2593400000	RCMC-5000-1A-P	0...1 A AC		100 A, 200 A, 300 A, 400 A, 500 A, 600 A, 800 A, 1000 A, 1500 A, 2000 A, 4000 A, 5000 A	1
2593410000	RCMC-5000-AQ-P	0...20 mA, 4...20 mA	0...5 V DC, 0...10 V DC, 0...225 mV AC, 0...333 mV AC	100 A, 200 A, 300 A, 400 A, 500 A, 600 A, 800 A, 1000 A, 1500 A, 2000 A, 4000 A, 5000 A	1
<b>Note</b>					

# Efficient implementation of testing and measurement switchgear

## Current and voltage transformer wiring solutions

When installing power monitoring components, a simple defective connection can result in the destruction of current transformers or voltage converters. Our specially developed test-disconnect terminal blocks are a safe way of solving this problem. Easy to use and available with different connection technologies, they facilitate error-free and convenient wiring. This guarantees the protection of your transformers and measuring devices and ensures safe, precise work. The modular concept of our terminal blocks for transformer switchgears also saves space in the cabinet.

### Avoiding errors through ease of use

Our test terminal blocks with tried-and-tested screw connection technology allow a large number of switching tasks to be overcome clearly and cost-effectively. The screws for the wire connection can only be accessed once the current transformer's short-circuit slider has been activated. This enhances safety as it prevents the accidental short-circuiting or opening of the converter circuit. Our pre-installed LST EM-BLOCK makes it easier to connect and short the current transformers, and is suitable for up to four phases.

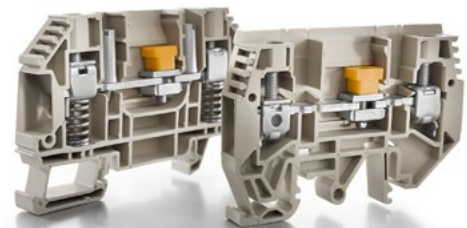
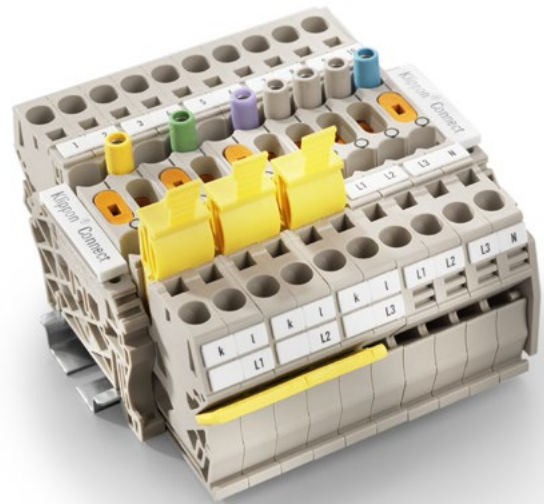

### Ordering data

Type	Order No.
LST EM-BLOCK	8000028895
LST CT-BLOCK	8000061153

### Technical data

	LST EM-Block	LST CT-Block
Connectable current transformers	4	4
Fuses for measurement voltage	3 phases	No
Fuse for supply voltage	Yes	No
Neutral conductor connection	2	No
PE connection	Yes	No
Markers	Yes	Yes

LST EM-Block

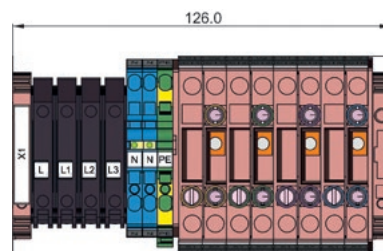

LST CT-Block

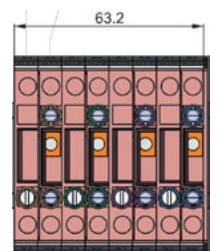



# Convenient retrofitting of energy management systems

## Ready-to-connect housings as the basis for flexible complete solutions

The industrial IoT offers numerous possibilities to increase system transparency, availability and efficiency. This is based on the communication capability of all system components. New machines are directly equipped with the necessary sensor technology. However, millions of existing systems need to be retrofitted to meet the necessary requirements.

With the ready-to-connect Plug&Play boxes and the connectivity boxes, Weidmüller is providing simple and cost-effective retrofit solutions that can be installed with minimal effort. Various measuring devices can be integrated into the housings to record consumption data - regardless of whether they are electrical or compressed air consumers.

In combination with Weidmüller's u-sense and u-connect components, this helps to create the foundations for consistent communication of consumption data from the sensor to the cloud. This allows for the transparent presentation of a system's total energy consumption, which is necessary for an energy management system aiming to increase efficiency and reduce electricity costs.

Both housing solutions are characterised by high modularity and interface diversity. Connectivity boxes have been specially designed to meet the requirements relevant to the introduction and expansion of energy management systems.

### Retrofit solutions

ready-to-connect solutions for System monitoring from Weidmüller

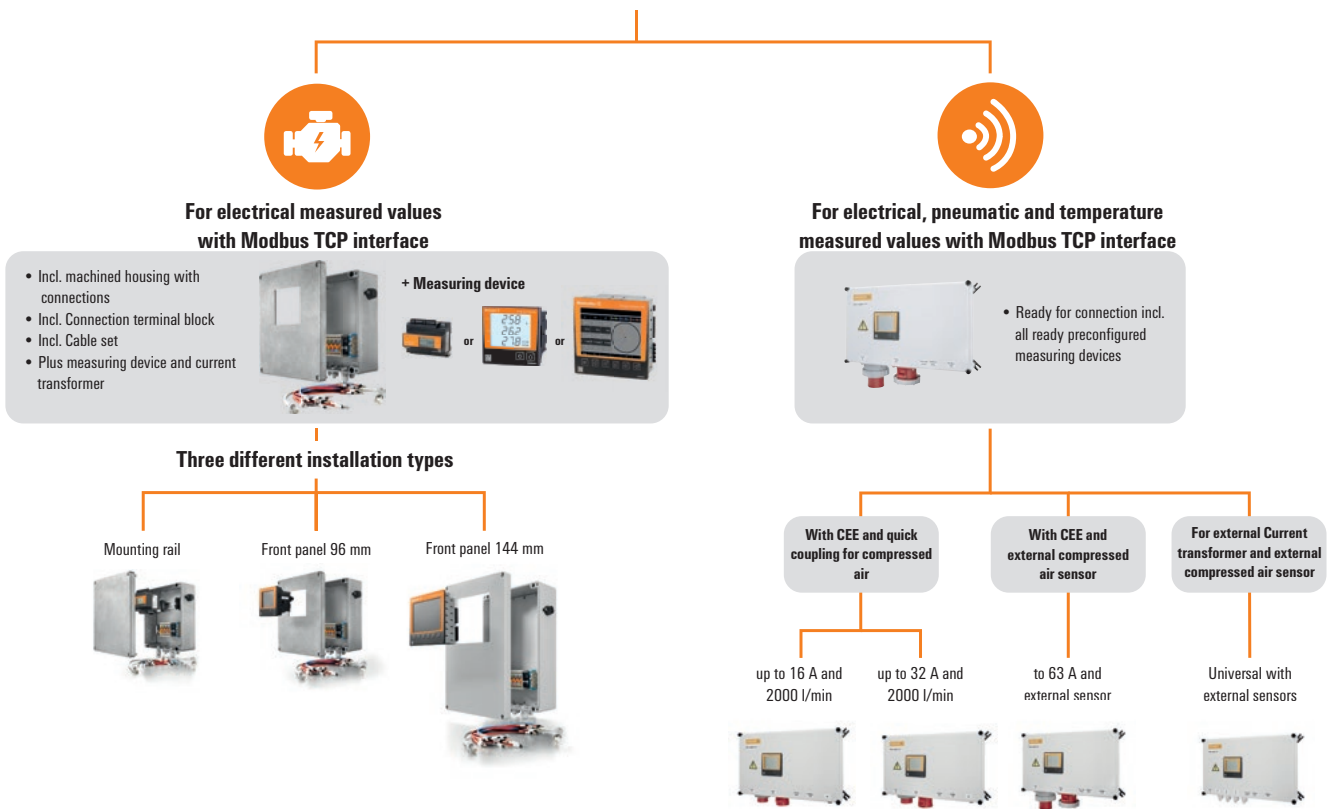

# Consistent integration of brownfield components into IIoT networks

## Plug&Play boxes as ready-to-connect solutions for machine operators

Digitalisation in production enables the use of Industry 4.0 technologies. One important added value of Industry 4.0 is the opportunity to increase energy efficiency. Since it is estimated that more than half of all systems do not yet have sufficient communication-capable components, retrofitted machine connection is needed, especially in brownfield components.

If existing machines are equipped with sensors and communication interfaces, these can continue to be used and do not have to be taken out of service due to a lack of Industry 4.0 interfaces.

With Weidmüller's ready-to-connect Plug&Play boxes, you can easily integrate existing machines into your IIoT network without having to make extensive changes to the control cabinet structures. Choosing the retrofit solution means that you gain transparency about the energy consumption as well as the efficiency of all machines, giving you the opportunity to effectively minimise energy costs.

With our 'Connect Brownfield to efficiency' concept, our products become the link between your machines and the downstream control system. The boxes thereby serve as

data collectors, while simultaneously acting as the basis for the evaluation and transparent presentation of your energy consumption. All you need is a network connection near the Plug&Play boxes.

- Integrated components for measuring energy or compressed air consumption
- Connection via standard connectors such as CEE, HDC, SAI and RJ45
- Reliable use in the field due to housing with protection class IP54
- Networking of the system components directly in the field - without adaptations in the control cabinet
- Easy mounting via optional magnetic holders
- High variability thanks to integrated or external measuring sensors
- Integration of preconfigured measuring devices
- High data security due to built-in device memory
- Immediate data recording and display using Weidmüller's integrated ecoExplorer go software

### Data collection on field level

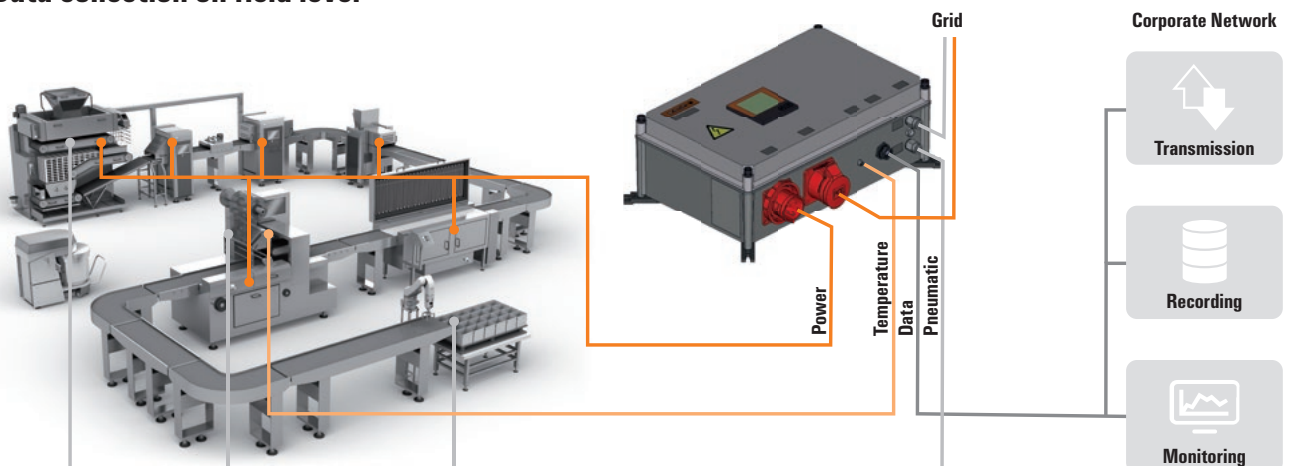

**Plug&Play box**

The Plug&Play device boxes are designed for weatherproof and stationary use. Protection class II according to IEC 60536 (VDE 0106. Part 1)

**PnP-16MOD-TCP**



**PnP-32-MOD-TCP**



**Technical data**

Rated current
Measurement range, voltage L-L, AC
Voltage supply
Airflow rate, min. / max.
Nominal input air pressure
Surge voltage category
Protection degree
Pollution severity
Air pressure (operation)
Type of mounting
<b>Inputs / Outputs</b>
Temperature input
Digital output configurable
Compressed-air connection available
Type of compressed-air connection
<b>Communication</b>
Interface
Protocol
<b>General data</b>
Width / Height / Depth
Weight
Ambient temperature
Humidity
<b>Note</b>

16 A
480 V
via the input measuring circuit
20...2000 l/min.
8 bar
II
IP54
4
≥ 795 hPa (height ≤ 2000 m) as per DIN EN 61131-2
Wall mounting; Connection side lying
Yes
Yes
Yes
Quick coupling for hoses with 10 mm
Ethernet 10/100 Base-TX (RJ-45 socket), Web server/e-mail TCP/IP, DHCP Client (BootP), Modbus/TCP (Port 502), ICMP (Ping), NTP, Modbus RTU over Ethernet (Port 8000), FTP, SNMP
530 / 340 / 225 mm
8640 g
0 °C...45 °C
35...85 % RH (at ambient temperature)

32 A
480 V
via the input measuring circuit
20...2000 l/min.
8 bar
II
IP54
4
≥ 795 hPa (height ≤ 2000 m) as per DIN EN 61131-2
Wall mounting; Connection side lying
Yes
Yes
Yes
Quick coupling for hoses with 10 mm
Ethernet 10/100 Base-TX (RJ-45 socket), Web server/e-mail TCP/IP, DHCP Client (BootP), Modbus/TCP (Port 502), ICMP (Ping), NTP, Modbus RTU over Ethernet (Port 8000), FTP, SNMP
530 / 340 / 225 mm
8940 g
0 °C...40 °C
35...85 % RH (at ambient temperature)

**Ordering data**

<b>Note</b>
-------------

Type	Qty.	Order No.
PnP-16-MOD-TCP	1	2716650000

Type	Qty.	Order No.
PnP-32-MOD-TCP	1	2716660000

**PNP-63-MOD-TCP**



63 A
480 V
via the input measuring circuit
II
IP54
4
≥ 795 hPa (height ≤ 2000 m) as per DIN EN 61131-2
Wall mounting; Connection side lying
Yes
Ethernet 10/100 Base-TX (RJ-45 socket), Web server/e-mail TCP/IP, DHCP Client (BootP), Modbus/TCP (Port 502), ICMP (Ping), NTP, Modbus RTU over Ethernet (Port 8000), FTP, SNMP
540 / 340 / 225 mm
8900 g
-10 °C...40 °C
0...75 % RH (at ambient temperature)

Type	Qty.	Order No.
PNP-63-MOD-TCP	1	2716670000

**PNP-U-MOD-TCP**



via current transformer 1 A/5 A
480 V
230 V
II
IP54
4
≥ 795 hPa (height ≤ 2000 m) as per DIN EN 61131-2
Wall mounting; Connection side lying
Yes
Ethernet 10/100 Base-TX (RJ-45 socket), Web server/e-mail TCP/IP, DHCP Client (BootP), Modbus/TCP (Port 502), ICMP (Ping), NTP, Modbus RTU over Ethernet (Port 8000), FTP, SNMP
550 / 340 / 225 mm
7320 g
-10 °C...45 °C
0...75 % RH (at ambient temperature)

Type	Qty.	Order No.
PNP-U-MOD-TCP	1	2716690000

# Excellent efficiency in one enclosure

## The Connectivity-Box in detail

Our EM-Connectivity-Box is a perfect combination of established products from the Weidmüller range. You can choose between aluminium and plastic enclosures to meet your requirements. The enclosures are milled to fit and are equipped with the requisite cable bushings. A modular terminal block to suit the measuring instruments to be fitted is already installed inside. There is also a labelled cable set which is specially adapted to the measuring equipment in question.

### The benefits at a glance

- Quicker and cheaper installation
- No significant changes required in the control cabinet or power distribution
- All the fuses, short-circuit devices, labelled cables and circuit diagrams are included
- No engineering required
- Protection class up to IP65 (EM-Connectivity-Box TS)
- Can be ordered as a standard item
- No minimum order



**Our solution contains**

- High-quality Weidmüller enclosure complete with cable bushings
- Measurement converter, disconnecter terminals, modular terminal blocks and fuse terminals
- Complete cable set, assembled and labelled, including Ethernet cable
- Supplied without measuring instrument and current transformer (available separately)

### Ordering data



Type	Type of protection	Dimensions (h x w x d)	Material	Order No.
EM-Connectivity-Box 96	IP54	310 x 230 x 111 mm	Aluminium	<b>8000028950</b>



EM-Connectivity-Box TS	IP65	310 x 230 x 111 mm	Aluminium	<b>8000028951</b>
------------------------	------	--------------------	-----------	-------------------



EM-Connectivity-Box 144	IP42	430 x 250 x 120 mm	Plastic	<b>8000028952</b>
-------------------------	------	--------------------	---------	-------------------



# Implement energy measurements simply and effectively

## Maximum energy transparency for minimum cost

The EM-Connectivity-Box from Weidmüller has the perfect properties to allow really effective introduction or extension of an Energy Management system. As well as the option of flexible selection of the measuring instrument, there is also perfect coordination between all associated products, especially the enclosure and connection terminals.



### Flexible choice of measuring instrument

Three different designs enable a good choice from our energy measuring instruments to suit your specific needs.



### High quality, assembled enclosure

Our energy measuring instruments are made from high-quality aluminium and plastic enclosures which already have all the necessary drilled holes and cut-outs.





### Components marked to prevent mix-ups

All cables, terminals and connections on the measuring instrument are clearly labelled in the factory to ensure quick, correct connections.



### Tried and tested Weidmüller modular terminal blocks

To enable optimum connection to our energy measuring instruments, we have specially selected a range of our tried and tested modular terminal blocks.



### Easy to install current transformers

Our cable conversion current transformers are easy to fit without disconnecting the cable. Alternatively, we offer a wide range of through and clip-on current transformers.



# Measure, convert and securely transmit currents

## From current transformer to retrofit solution



### Current transformers

Current transformers are indispensable for recording electrical parameters. They convert "high" primary currents of currently up to 5 kA from a single or three-phase network into "low" secondary currents (5 A or 1 A). These currents can then be processed by the energy meters. Weidmüller offers various different versions: Rogowski coils, plug-in, rod and cable-type current transformers.



### Measurement transformer disconnect terminals

Measurement transformer disconnect terminals are urgently required for the safe operation of current transformers. A wrong connection can destroy a current transformer. Measurement transformer disconnect terminals are a safe method of solving this problem. As a leading supplier of line connectors, Weidmüller has developed special measurement transformer disconnect terminals in close cooperation with users. These stand out from the competition thanks to their space-saving design with extremely low-maintenance screw connections and a comprehensive range of accessories.



### Retrofitting energy management solutions

In today's manufacturing facilities, millions of unlinked machines and systems are still in operation. Most of them are connected to the electrical network or the compressed air system.

With Weidmüller's retrofit solutions, energy consumption can be recorded very easily and made transparent without having to enter the machine's control cabinet.

The Industrial IoT components from Weidmüller can then be used for further processing, communication and analysis of the recorded data.

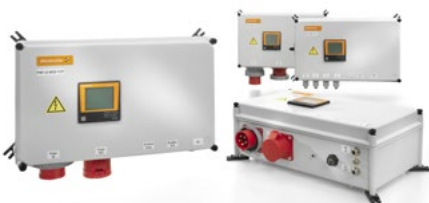

### Plug&play boxes

The establishment of an energy management system requires precise knowledge of all energy consumption within a system. Our PnP boxes are the ideal retrofit solution for all existing system components. They can be used to record the energy or compressed air consumption of devices and machines in the field that do not yet have the necessary sensor equipment. For this purpose, appropriate measuring devices are simply integrated into the box and the consumers are connected via suitable interfaces on the box. The boxes are easy to install and can be easily integrated into existing systems.



### Modbus TCP/RTU gateway

Serial and Ethernet-based Modbus devices can be flexibly connected with each other. The gateway facilitates data communication between energy-measuring devices with the serial Modbus RTU/ASCII interface and a Modbus TCP Master, for example to display and analyse energy measurement data. Special characteristics of our Modbus gateways include:

- RTU slave mode for communication between up to 16 TCP masters and 31 serial slaves
- RTU master mode for communication between 1 serial master and up to 31 TCP slaves
- Integrated 2-port switch for setting up a linear topology

## Individual combination – perfect addition

### Products for your comprehensive energy monitoring system



#### Worldwide usage in different applications and different industries

Weidmüller Industrial Ethernet components are the perfect link for data communication between Ethernet enabled devices in industrial automation. By supporting various topologies and protocols, they can be used in many industrial applications.

As a complete provider of industrial network infrastructure for machine and equipment manufacture, we offer a wide range of switch products to suit the individual needs of our customers. In particular, Gigabit switches (unmanaged and managed) and media converters, Power-over-Ethernet switches, WLAN devices and serial/Ethernet converters to meet the highest requirements and provide a reliable and flexible Ethernet communication. An extensive passive product portfolio consisting of RJ 45 and fibre optic connectors and cables make Weidmüller your partner for industrial Ethernet solutions.



#### Optimum power supply for automation technology

The switch-mode power supplies feature a high efficiency, compact dimensions and minimal heat generation. They are an excellent and reliable solution for providing power in all automation applications – safely providing 24 V DC voltage. The different product series are optimised for the automation industry: they feature Ex approvals for the processing industry, a flat shape perfect for distribution tasks within buildings and provide decentralised control voltages. All-purpose usage: with a wide range of AC/DC inputs, single-, double- or three-phase versions and a wide temperature range. Additional performance increases are possible using simple parallel connection. Weidmüller switch-mode power supplies are reliable usable for all applications because of their high efficiency and their resistance to both short circuits and overloads.

Weidmüller offers a system of one- and three-phase switchmode power supplies especially for the PROtop family.



#### Powerful Analogue signal conditioning

Considering the increase of automation, isolating amplifiers are required which convert, isolate, monitor, protect and visualise your digital and analogue signal values from industrial and process automation, e.g. temperature, pressure, level, flow volumes, weight, and speed. Our signal converters for DC standard signals, 4-20 mA and 0-10 V isolating amplifiers, switching amplifiers, frequency converters, and threshold switches are characterised by a high level of accuracy, universality and a wide assortment of variants.



#### Making process data comprehensively usable

IoT gateway - the real all-rounder for your IoT applications  
Our IoT gateway enables the recording of machine data and provides access to field devices and controllers via various protocols and interfaces.

Data pre-processing is carried out with the open IoT standard Node-RED, whose large community offers a variety of solutions. Interfaces to in-house IT systems as well as to cloud systems such as Azure, AWS, IBM are possible, as is integration into the u-link remote access service for worldwide remote maintenance of the system.

## Achieving maximum efficiency in the control cabinet

### With great savings potential and optimum system performance

u-remote from Weidmüller is the reliable interface between field bus and field level in automation. The modular system is based on various components: a fieldbus coupler, up to 64 I/O modules, optional power-feed modules and a wealth of accessories, such as markers and terminating elements.

The fieldbus coupler is the central link between the various field bus standards and the u-remote system bus. At the same time, up to 64 I/O modules are supplied via its integrated power contacts. The well-engineered technology of the connection system enables  $2 \times 10 \text{ A}$  to be supplied for the input and output modules and the system voltage to be fully supplied through the fieldbus coupler. Every fieldbus coupler provides direct access to the u-remote system via a web server without additional software having to be installed. This means that the system can be parameterised and its configuration checked. Inputs and outputs can also be checked or influenced. The connection may take the form of an Ethernet-based field bus or micro USB. The u-remote fieldbus couplers are integrated in the standard simple manner. The corresponding development environments of the control systems and the device description files available online, e.g. GSD, ESD, EDS oder XML, can be used to easily perform the necessary settings.

The modularly structured I/O modules are unique in that they allow the sensor and actuator wiring to be designed in both a robust and plug-in manner. This allows the electronics to be replaced at any time even with permanent wiring. This achieves an invaluable time saving, in terms of both wiring inaccessible cabinets and rapidly replacing sensors. Thanks to the "PUSH IN" technology for up to  $1.5 \text{ mm}^2$ , in their narrowest form of 11.5 mm, the modularly structured u-remote I/O modules can be used for all sensor and actuator connections with a very high connection density. A clear status and diagnosis display on the connection also ensures rapid and precise checks for individual sensors and actuators.

More intelligent automation more easily specified:  
u-remote facilitates your planning and offers unique functions.



**More Performance.  
Simplified.**  
u-remote.

#### Innovative functions for more efficient automation solutions

With u-remote, Weidmüller has completely rethought the I/O technology for IP20 environments. You can thus expect a system that is full of clever details and allows you to install innovative, cost-saving and easy-to-handle automation solutions in your project.



**Why waste space?**

Design your cabinets one size smaller: u-remote, with the highest connection density on a module, offers you the most slender module width and a far lower space requirement for power-feed modules - an unrivaled channel density and extremely flexible design options.

**Simply plug and go**

The plug-in connection level allows sensors and actuators to be connected with pre-assembled cables. This means improved time benefits, better handling, and minimises the number of mistakes in system wiring. Decentralised automation modules in particular are so very easy to transfer into productive operation.

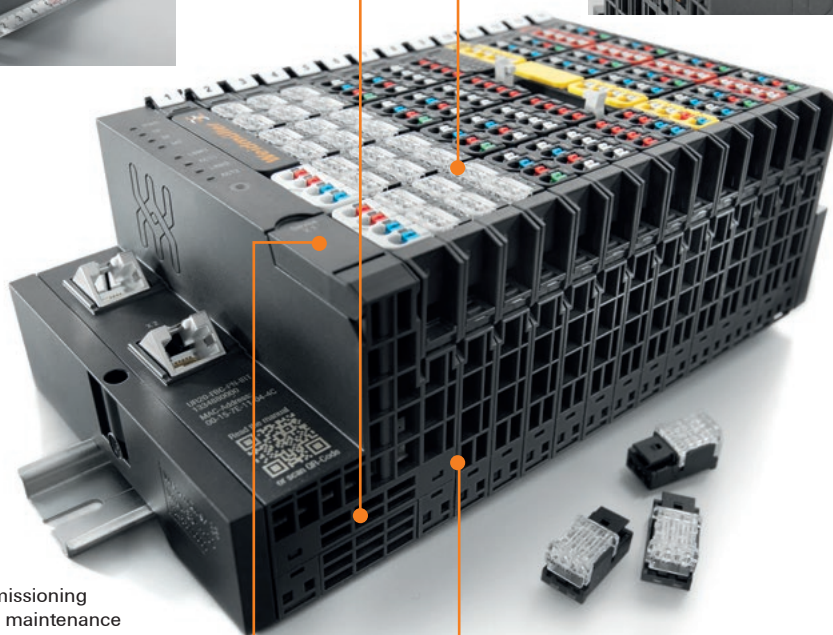
**Diagnostics, even without a control connection**

u-remote simplifies machine commissioning section-by-section and accelerates maintenance work with its integrated web server. Thanks to the high performance diagnostic tool, you can simulate the functionality of inputs and outputs prior to control connection.

You can conduct plain text error analyses using any standard browser - whether you're working on-site or remotely.

**Intelligently separated**

u-remote separates the supply for inputs and outputs using two 10 A current paths which are able to withstand high loads. High productivity translates into fewer power-feed modules and therefore more space and less planning. And your system can be quickly maintained while retaining full diagnostic capability, as inputs and outputs can be switched off independently of one another.



**More products in our  
online catalogue:  
[catalog.weidmueller.com](http://catalog.weidmueller.com)**



## ModbusTCP

- Dual LAN mode
- 2 x 10 A current path
- Various Modbus services
- Web server
- System supply for 64 I/O modules
- Temperature range: -20... +60 °C

## UR20-FBC-MOD-TCP-V2



### Technical data

#### System data

Connection type	2 x RJ45 plug-in connectors
Field bus protocol	Modbus/TCP
Process data	8 kByte
Parameter data	1024 Byte
Diagnostic data	1024 Byte
max. number of modules	64
Configuration interface	Micro USB 2.0
Transmission rate of field bus, max.	100 Mbit/s
Transmission speed of system bus, max.	48 Mbit/s

#### Supply

Supply voltage for inputs	24 V DC +20 %/ -15 %
Supply voltage for outputs	24 V DC +20 %/ -15 %
Feed current for $I_{IN}$ (input current path) , max.	10 A
Feed current for $I_{OUT}$ (output current path) , max.	10 A
Current consumption $I_{IN}$ (power segment of the field bus coupler), typ.	112 mA

#### General data

Weight	223 g
Dimensions H x W x D	120 mm / 52 mm / 76 mm

#### Note

### Ordering data

#### Module variants

Fieldbus coupler, ModbusTCP

#### Note

### Accessories

Coding elements	KOSM BHZ5.00	100	1483050000
Termination kit	UR20-EBK-ACC	5	1346610000
Swivel marker	UR20-SM-ACC	20	1339920000
Connection marker for pusher custom printing	PM 2.7/2.6 MC SDR	192	1323700000
Connection marker for pusher neutral	PM 2.7/2.6 MC NE WS	960	1323710000
Module marker for custom printing	DEK 5/8-11.5 MC SDR	100	1341610000
Module marker for neutral	DEK 5/8-11.5 MC NE WS	500	1341630000
Thermotransfer version (Material: Polyester)	THM UR20 GE	1	1429910000
Thermotransfer version (material: polyester)	THM UR20 WS	1	1429420000
Paper version for Laserprinter	ESO UR20 DIN A4 WS	10	1429430000
USB cable (USB A to Micro USB)	IE-USB-A-MICRO-1.8M	1	1487980000

#### Replacement parts

Plug-in connector unit

#### Note

Type	Qty.	Order No.
UR20-FBC-MOD-TCP-V2	1	2476450000

A termination kit (UR20-EBK-ACC) is included in the coupler package

Type	Qty.	Order No.
UR20-PK-2476450000-SP	5	2485280000

1 roll = 1000 labels = 1 Qty.  
1 sheet = 60 labels = 1 unit

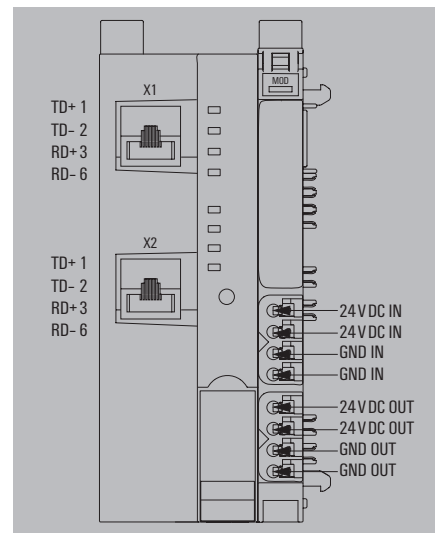

Product standard	IEC 61131-2
EMC	EN 61000
ATEX	EN 60079
UL	UL 61010-2-201
MSIP	MSIP-REM-WMG-2476450000
ABS (American Bureau of Shipping)	
BSH (Federal Maritime and Hydrographic Agency of Germany)	
BV (Bureau Veritas)	
DNV GL (Det Norske Veritas) (Germanischer Lloyd)	
LR (Lloyd's Register)	
RINA (Registro Italiano Navale)	

## Power measurement module

Power measurement via 1- or 3-phase, rated voltage to 300 V<sub>eff</sub>

The power measurement module is used for recording and processing of currents and voltages on one or three-phase loads up to a rated voltage of 300 V<sub>eff</sub> AC (phase to neutral conductor). Reactive, apparent harmonic and active power, energy consumption, phase angle, and many other electrical parameters are measured or calculated by the module. The transmitted data via the process data of the different fieldbuses can be selected via parameters.

The Power measurement module can be easily integrated into existing automation solutions with u-remote. Using split-core current transformers it is not even necessary to intervene in the existing installation. Currents from 1 A or up to 5 A can be measured directly, higher currents can be measured with split-core or plugin current transformers from Weidmüller.

UR20-3EM-230V-AC



**3EM-230V-AC**

- 1- or 3-phase power measurement for 1 A or 5 A (with or without transformer)
- Measurement in the phase conductor
- 16 bit resolution
- Power-/ reactive power measurement
- Energy meter Active / reactive
- Power factor
- Frequency measurement 45 ... 65 Hz
- Analysis of 31 harmonics

**Technical data**

<b>System data</b>	
Interface	u-remote system bus
Transmission speed of system bus, max.	48 Mbit
Galvanic isolation	500 V DC between the current paths
<b>Supply</b>	
Voltage supply	24 V DC +20 %/- 15 %, via the system bus
Current consumption $I_m$ (power segment of the field bus coupler), typ.	8 mA
Current consumption $I_m$ (the respective power segment)	12 mA
<b>Analogue inputs</b>	
Number	3
Rated voltage	300 V <sub>eff</sub> (L-N)
Resolution	16 bit per channel (internal 24 bit)
Sampling rate of current measurement	3,300 samples/s
Frequency of the supply system	45...65 Hz
Analysis of harmonic	31 (Blackmann-Harris Window)
Power rating	0...1 A / 0...5 A AC
Insulation	1.5 kV <sub>eff</sub> (input / system)
Nominal peak voltage	4
Category for voltage measurements	CAT II (IEC 61010 Part 1)
Measurement method	High Resolution Delta Sigma (current measurement in outer conductor)
Measurement accuracy	0.5% in relation to final value (U / I), 1% for the calculated values
Connectable converter ratios	1 ... 1000
Input impedance voltage	2.4 MΩ per channel
Measurement resistance (shunt)	4 mΩ (at 5 A), 20 mΩ (at 1 A)
<b>General data</b>	
Weight	90 g
Dimensions H x W x D	120 mm / 11.5 mm / 76 mm
<b>Note</b>	

**Ordering data**

<b>Module variants</b>	
	Power measurement module, 3 channels
<b>Note</b>	

**Accessories**

	Coding elements
	Termination kit
	Swivel marker
	Connection marker for pusher custom printing
	Connection marker for pusher neutral
	Module marker for custom printing
	Module marker for neutral
	Thermotransfer version (Material: Polyester)
	Thermotransfer version (material: polyester)
	Paper version for Laserprinter
<b>Replacement parts</b>	
	Electronic module
	Basic module
	Plug-in connector unit
<b>Note</b>	

**UR20-3EM-230V-AC**

<b>System data</b>	
Interface	u-remote system bus
Transmission speed of system bus, max.	48 Mbit
Galvanic isolation	500 V DC between the current paths
<b>Supply</b>	
Voltage supply	24 V DC +20 %/- 15 %, via the system bus
Current consumption $I_m$ (power segment of the field bus coupler), typ.	8 mA
Current consumption $I_m$ (the respective power segment)	12 mA
<b>Analogue inputs</b>	
Number	3
Rated voltage	300 V <sub>eff</sub> (L-N)
Resolution	16 bit per channel (internal 24 bit)
Sampling rate of current measurement	3,300 samples/s
Frequency of the supply system	45...65 Hz
Analysis of harmonic	31 (Blackmann-Harris Window)
Power rating	0...1 A / 0...5 A AC
Insulation	1.5 kV <sub>eff</sub> (input / system)
Nominal peak voltage	4
Category for voltage measurements	CAT II (IEC 61010 Part 1)
Measurement method	High Resolution Delta Sigma (current measurement in outer conductor)
Measurement accuracy	0.5% in relation to final value (U / I), 1% for the calculated values
Connectable converter ratios	1 ... 1000
Input impedance voltage	2.4 MΩ per channel
Measurement resistance (shunt)	4 mΩ (at 5 A), 20 mΩ (at 1 A)
<b>General data</b>	
Weight	90 g
Dimensions H x W x D	120 mm / 11.5 mm / 76 mm
<b>Note</b>	

Type	Qty.	Order No.
UR20-3EM-230V-AC	1	2007420000

Type	Qty.	Order No.
KOSM BHZ5.00	100	1483050000
UR20-EBK-ACC	5	1346610000
UR20-SM-ACC	20	1339920000
PM 2.7/2.6 MC SDR	192	1323700000
PM 2.7/2.6 MC NE WS	960	1323710000
DEK 5/8-11.5 MC SDR	100	1341610000
DEK 5/8-11.5 MC NE WS	500	1341630000
THM UR20 GE	1	1429910000
THM UR20 WS	1	1429420000
ESO UR20 DIN A4 WS	10	1429430000
UR20-EM-2007420000-SP	1	1562270000
UR20-BM-SP	5	1350930000
UR20-PK-2007420000-SP	5	2068630000

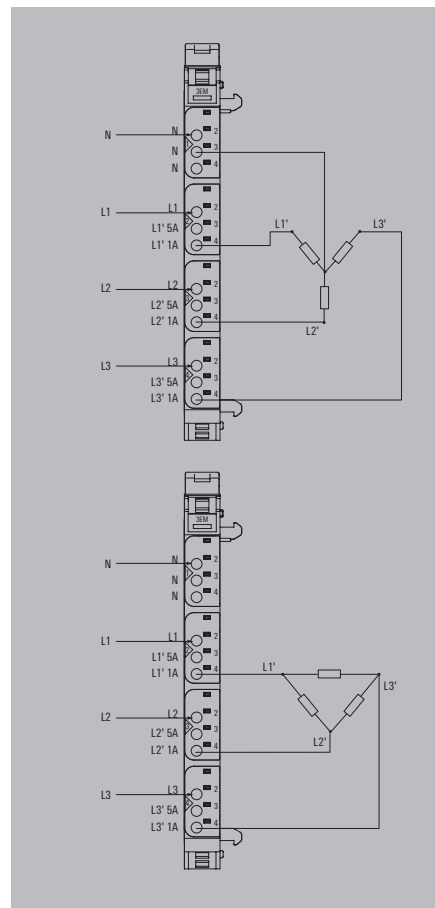

Product standard	IEC 61131-2
EMC	EN 61000
ATEX	EN 60079
UL	UL 61010-2-201
MSIP	
ABS (American Bureau of Shipping)	
BSH (Federal Maritime and Hydrographic Agency of Germany)	
BV (Bureau Veritas)	
DNV GL (Det Norske Veritas) (Germanischer Lloyd)	
LR (Lloyd's Register)	
RINA (Registro Italiano Navale)	

## Automation kit

## Digital input modules - 4DI-P

- 4 digital inputs for sensors such as transmitters, switches and proximity sensors
- Positive switching
- Reverse polarity protection
- 2-wire, 3-wire, 3-wire+FE connection
- Input filter can be set channel by channel
- Integrated sensor supply
- Types 1 and 3 acc. to IEC 61131-2

## UR20-4DI-P



## Technical data

## System data

Interface  
Transmission speed of system bus, max.  
Galvanic isolation

## Supply

Voltage supply  
Current consumption  $I_m$  (power segment of the field bus coupler), typ.  
Current consumption  $I_m$  (the respective power segment)

## Digital inputs

Number of digital inputs  
Type  
Input filter  
Input voltage, low  
Input voltage, high  
Sensor supply  
Sensor connection  
Reverse polarity protection  
Module diagnosis  
Individual channel diagnosis

## General data

Weight  
Dimensions H x W x D

## Note

u-remote system bus  
48 Mbit  
500 V DC between the current paths

24 V DC  $\pm 20\%$  /  $-15\%$ , via the system bus  
8 mA  
< 10 mA

4  
Types 1 and 3, EN 61131-2  
configurable  
< 5 V  
> 11 V  
Yes  
2-wire, 3-wire, 3-wire + FE  
Yes  
Yes  
No

87 g  
120 mm / 11.5 mm / 76 mm

## Ordering data

## Module variants

Digital input module, 4 channels

## Note

## Accessories

Termination kit  
Swivel marker  
Connection marker for pusher neutral  
Connection marker for pusher custom printing  
Module marker for custom printing  
Module marker for neutral

## Replacement parts

Electronic module  
Basic module  
Plug-in connector unit

## Note

Type	Qty.	Order No.
UR20-4DI-P	1	1315170000

Type	Qty.	Order No.
UR20-EBK-ACC	5	1346610000
UR20-SM-ACC	20	1339920000
PM 2.7/2.6 MC NE WS	960	1323710000
PM 2.7/2.6 MC SDR	192	1323700000
DEK 5/8-11.5 MC SDR	100	1341610000
DEK 5/8-11.5 MC NE WS	500	1341630000

UR20-EM-1315170000-SP	1	1346640000
UR20-BM-SP	5	1350930000
UR20-PK-1315170000-SP	5	1346440000

1 roll = 1000 label = 1 Qty.  
1 sheet = 60 label = 1 Qty.

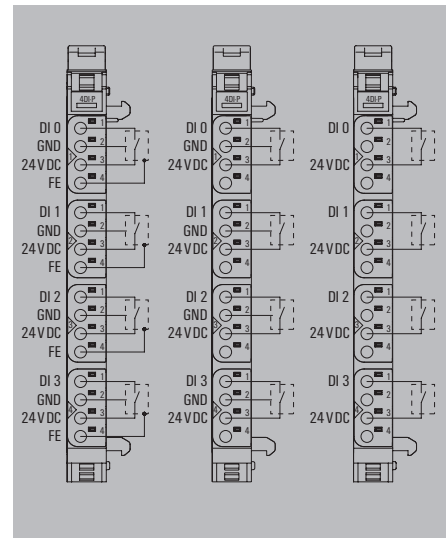

Product standard	IEC 61131-2
EMC	EN 61000
ATEX	EN 60079
UL	UL 61010-2-201
MSIP	MSIP-REM-WMG-1315170000

ABS (American Bureau of Shipping)  
BSH (Federal Maritime and Hydrographic Agency of Germany)  
BV (Bureau Veritas)  
DNV GL (Det Norske Veritas) (Germanischer Lloyd)  
LR (Lloyd's Register)  
RINA (Registro Italiano Navale)

## Digital input module - 8DI-P-2W

- 8 digital inputs for sensors such as transmitters, switches and proximity sensors
- Positive switching
- Reverse polarity protection
- 2-wire connection
- Input filter can be set channel by channel
- Types 1 and 3 acc. to IEC 61131-2

### Technical data

#### System data

Interface  
Transmission speed of system bus, max.  
Galvanic isolation

#### Supply

Voltage supply  
Current consumption  $I_m$  (power segment of the field bus coupler), typ.  
Current consumption  $I_m$  (the respective power segment)

#### Digital inputs

Number of digital inputs  
Type  
Input filter  
Input voltage, low  
Input voltage, high  
Sensor supply  
Sensor connection  
Reverse polarity protection  
Module diagnosis  
Individual channel diagnosis

#### General data

Weight  
Dimensions H x W x D

#### Note

### Ordering data

#### Module variants

Digital input module, 8 channels, 2-wire

#### Note

### Accessories

Coding elements  
Termination kit  
Swivel marker  
Connection marker for pusher custom printing  
Connection marker for pusher neutral  
Module marker for custom printing  
Module marker for neutral  
Thermotransfer version (Material: Polyester)  
Thermotransfer version (material: polyester)  
Paper version for Laserprinter

#### Replacement parts

Electronic module  
Basic module  
Plug-in connector unit

#### Note

## UR20-8DI-P-2W



u-remote system bus  
48 Mbit  
500 V DC between the current paths

24 V DC +20 %/-15 %, via the system bus  
8 mA  
30 mA

8  
Types 1 and 3, EN 61131-2  
configurable  
< 5 V  
> 11 V  
Yes  
2-wire  
Yes  
Yes  
No

85 g  
120 mm / 11.5 mm / 76 mm

Type	Qty.	Order No.
UR20-8DI-P-2W	1	1315180000

Type	Qty.	Order No.
KOSM BHZ5.00	100	1483050000
UR20-EBK-ACC	5	1346610000
UR20-SM-ACC	20	1339920000
PM 2.7/2.6 MC SDR	192	1323700000
PM 2.7/2.6 MC NE WS	960	1323710000
DEK 5/8-11.5 MC SDR	100	1341610000
DEK 5/8-11.5 MC NE WS	500	1341630000
THM UR20 GE	1	1429910000
THM UR20 WS	1	1429420000
ESD UR20 DIN A4 WS	10	1429430000

UR20-EM-1315180000-SP	1	1490220000
UR20-BM-SP	5	1350930000
UR20-PK-1315180000-SP	5	1346430000

1 roll = 1000 label = 1 Qty.  
1 sheet = 60 label = 1 Qty.

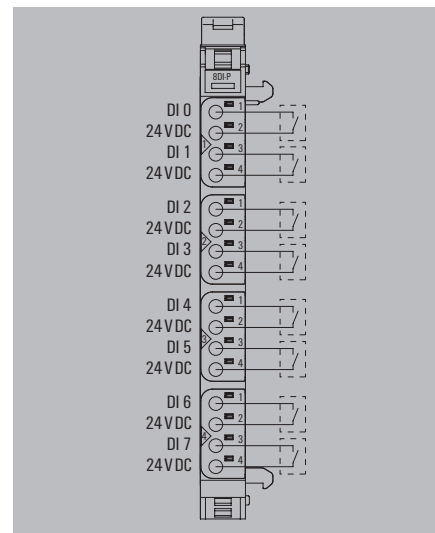

Product standard	IEC 61131-2
EMC	EN 61000
ATEX	EN 60079
UL	UL 61010-2-201
MSIP	MSIP-REM-WMG-1315180000
ABS (American Bureau of Shipping)	
BSH (Federal Maritime and Hydrographic Agency of Germany)	
BV (Bureau Veritas)	
DNV GL (Det Norske Veritas) (Germanischer Lloyd)	
LR (Lloyd's Register)	
RINA (Registro Italiano Navale)	

## Automation kit

## Analogue input module - 4AI-UI-12

- 4 analogue inputs
- Parameterisable inputs (voltage, current)
- 12-bit resolution
- 2-wire, 3-wire and 3-wire+FE connection
- Accuracy 0.25 % FSR

## UR20-4AI-UI-12



## Technical data

## System data

Interface  
Transmission speed of system bus, max.  
Galvanic isolation

## Supply

Voltage supply  
Current consumption  $I_m$  (power segment of the field bus coupler), typ.  
Current consumption  $I_m$  (the respective power segment)

## Analogue inputs

Number of analogue inputs  
Type

Resolution

Accuracy

Sensor supply

Sensor connection

Conversion time

Internal resistance U

Internal resistance I

Reverse polarity protection

Module diagnosis

Individual channel diagnosis

Short-circuit-proof

## General data

Weight

Dimensions H x W x D

## Note

u-remote system bus

48 Mbit

DC 500 V between current paths

24 V DC +20 %/-15 %, via the system bus

8 mA

25 mA + sensor feed

4

1. U (0...5 V, 0...10 V, 1...5 V, 2...10 V,  $\pm 10$  V), 2. I (0-20 mA or 4-20 mA), Adjustable input for current or voltage

12-bit

0.1% FSR

Yes

2-wire, 3-wire, 3-wire + FE

1 ms

100 k $\Omega$ 41.2  $\Omega$ 

Yes

Yes

No

Yes

87 g

120 mm / 11.5 mm / 76 mm

## Ordering data

## Module variants

Analogue input module, 4 channels, 12 bits

## Note

## Accessories

Coding elements  
Termination kit  
Swivel marker  
Connection marker for pusher custom printing  
Connection marker for pusher neutral  
Module marker for custom printing  
Module marker for neutral  
Thermotransfer version (Material: Polyester)  
Thermotransfer version (material: polyester)  
Paper version for Laserprinter

## Replacement parts

Electronic module  
Basic module  
Plug-in connector unit

## Note

Type	Qty.	Order No.
UR20-4AI-UI-12	1	1394390000

Type	Qty.	Order No.
KOSM BHZ5.00	100	1483050000
UR20-EBK-ACC	5	1346610000
UR20-SM-ACC	20	1339920000
PM 2.7/2.6 MC SDR	192	1323700000
PM 2.7/2.6 MC NE WS	960	1323710000
DEK 5/8-11.5 MC SDR	100	1341610000
DEK 5/8-11.5 MC NE WS	500	1341630000
THM UR20 GE	1	1429910000
THM UR20 WS	1	1429420000
ESD UR20 DIN A4 WS	10	1429430000

UR20-EM-1394390000-SP	1	1434230000
UR20-BM-SP	5	1350930000
UR20-PK-1394390000-SP	5	1484030000

1 roll = 1000 label = 1 Qty.  
1 sheet = 60 label = 1 Qty.

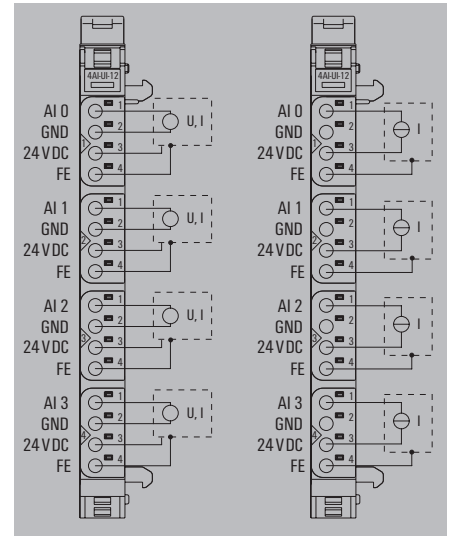

Product standard	IEC 61131-2
EMC	EN 61000
ATEX	EN 60079
UL	UL 61010-2-201
MSIP	MSIP-REM-WMG-1394390000
ABS (American Bureau of Shipping)	
BSH (Federal Maritime and Hydrographic Agency of Germany)	
BV (Bureau Veritas)	
DNV GL (Det Norske Veritas) (Germanischer Lloyd)	
LR (Lloyd's Register)	
RINA (Registro Italiano Navale)	

## Temperature module - 4AI-RTD-DIAG

- 16-bit resolution
- Individual channel diagnosis
- Automatic 50 and 60 Hz suppression
- For 2-, 3- and 4-wire RTDs
- High accuracy
- For virtually all common sensors
- Temperature measurement via resistor

### Technical data

System data	
Interface	u-remote system bus
Transmission speed of system bus, max.	48 Mbit
Galvanic isolation	DC 500 V between current paths
Supply	
Voltage supply	24 V DC +20 %/-15 %, via the system bus
Current consumption $I_m$ (power segment of the field bus coupler), typ.	8 mA
Current consumption $I_m$ (the respective power segment)	< 20 mA
Analogue inputs	
Number of analogue inputs	4
Type	Pt100, Pt200, Pt500, Pt1000, Ni100, Ni120, Ni 200, Ni500, Ni1000, Cu10, 40Ω, 80Ω, 150Ω, 300Ω, 500Ω, 1kΩ, 2kΩ, 4kΩ
Resolution	16 Bit
Accuracy	0.2% FSR / 0.3% FSR for Ni sensors / 0.6% FSR for Cu10
Sensor connection	2-wire, 3-wire, 4-wire
Temperature coefficient	≤ 50 ppm/K
Temperature range	-200...850 °C
Conversion time	adjustable, 36...240 ms
Internal resistance U	1 MΩ
Reverse polarity protection	Yes
Module diagnosis	Yes
Individual channel diagnosis	Yes
General data	
Weight	91 g
Dimensions H x W x D	120 mm / 11.5 mm / 76 mm
Note	

### Ordering data

Module variants	
Analogue input module, 4 channels, RTD	
Note	

### Accessories

Coding elements	
Termination kit	
Swivel marker	
Connection marker for pusher custom printing	
Connection marker for pusher neutral	
Module marker for custom printing	
Module marker for neutral	
Thermotransfer version (Material: Polyester)	
Thermotransfer version (material: polyester)	
Paper version for Laserprinter	
Replacement parts	
Electronic module	
Basic module	
Plug-in connector unit	
Note	

## UR20-4AI-RTD-DIAG



u-remote system bus	
48 Mbit	
DC 500 V between current paths	
24 V DC +20 %/-15 %, via the system bus	
8 mA	
< 20 mA	
4	
Pt100, Pt200, Pt500, Pt1000, Ni100, Ni120, Ni 200, Ni500, Ni1000, Cu10, 40Ω, 80Ω, 150Ω, 300Ω, 500Ω, 1kΩ, 2kΩ, 4kΩ	
16 Bit	
0.2% FSR / 0.3% FSR for Ni sensors / 0.6% FSR for Cu10	
2-wire, 3-wire, 4-wire	
≤ 50 ppm/K	
-200...850 °C	
adjustable, 36...240 ms	
1 MΩ	
Yes	
Yes	
Yes	
91 g	
120 mm / 11.5 mm / 76 mm	

Type	Qty.	Order No.
UR20-4AI-RTD-DIAG	1	1315700000

Type	Qty.	Order No.
KOSM BHZ5.00	100	1483050000
UR20-EBK-ACC	5	1346610000
UR20-SM-ACC	20	1339920000
PM 2.7/2.6 MC SDR	192	1323700000
PM 2.7/2.6 MC NE WS	960	1323710000
DEK 5/8-11.5 MC SDR	100	1341610000
DEK 5/8-11.5 MC NE WS	500	1341630000
THM UR20 GE	1	1429910000
THM UR20 WS	1	1429420000
ESO UR20 DIN A4 WS	10	1429430000
UR20-EM-1315700000-SP	1	1347290000
UR20-BM-SP	5	1350930000
UR20-PK-1315700000-SP	5	1484040000
1 roll = 1000 label = 1 Qty. 1 sheet = 60 label = 1 Qty.		

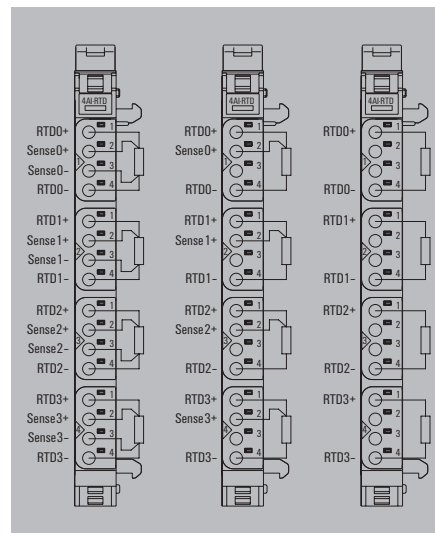

Product standard	IEC 61131-2
EMC	EN 61000
ATEX	EN 60079
UL	UL 61010-2-201
MSIP	MSIP-REM-WMG-1315700000
ABS (American Bureau of Shipping)	
BSH (Federal Maritime and Hydrographic Agency of Germany)	
BV (Bureau Veritas)	
DNV GL (Det Norske Veritas) (Germanischer Lloyd)	
LR (Lloyd's Register)	
RINA (Registro Italiano Navale)	

## Automation kit

## Digital counter module - 2CNT-100

- Counter data width 32-Bit
- Maximum input frequency 100 kHz
- Operation mode impulse, direction, 1-, 2- or 4-times
- Sensor feed
- Input filter adjustable up to 1 ms

## UR20-2CNT-100



## Technical data

System data	
Interface	u-remote system bus
Transmission speed of system bus, max.	48 Mbit
Galvanic isolation	500 V DC between the current paths
Supply	
Voltage supply	24 V DC +20 %/-15 %, via the system bus
Current consumption $I_M$ (power segment of the field bus coupler), typ.	8 mA
Current consumption $I_M$ (the respective power segment)	35 mA (plus output current)
Digital inputs	
Number	2
Input type	for Type 1 and Type 3 sensors as per IEC 61131-2
Input filter	configurable
Input voltage, low	< 5 V
Input voltage, high	> 11 V
Sensor supply	Yes
Sensor connection	2-wire, 3-wire
Reverse polarity protection	Yes
Module diagnosis	Yes
Individual channel diagnosis	Yes
Max. input current per channel	3.5
Counter width	32
Max. input frequency	100 kHz
max. count rate	400 kHz
Mode of operation	Pulse, Direction, 1-, 2-, 4-times
General data	
Weight	85 g
Dimensions H x W x D	120 mm / 11.5 mm / 76 mm
Note	

## Ordering data

Module variants	
Digital counter module, 2 channel, 100 kHz	
Note	

## Accessories

Coding elements	
Termination kit	
Swivel marker	
Connection marker for pusher custom printing	
Connection marker for pusher neutral	
Module marker for custom printing	
Module marker for neutral	
Thermotransfer version (Material: Polyester)	
Thermotransfer version (material: polyester)	
Paper version for Laserprinter	
Replacement parts	
Electronic module	
Basic module	
Plug-in connector unit	
Note	

Type	Qty.	Order No.
UR20-2CNT-100	1	1315590000

Type	Qty.	Order No.
KOSM BHZ5.00	100	1483050000
UR20-EBK-ACC	5	1346610000
UR20-SM-ACC	20	1339920000
PM 2.7/2.6 MC SDR	192	1323700000
PM 2.7/2.6 MC NE WS	960	1323710000
DEK 5/8-11.5 MC SDR	100	1341610000
DEK 5/8-11.5 MC NE WS	500	1341630000
THM UR20 GE	1	1429910000
THM UR20 WS	1	1429420000
ESO UR20 DIN A4 WS	10	1429430000
UR20-EM-1315590000-SP	1	1347150000
UR20-BM-SP	5	1350930000
UR20-PK-1315590000-SP	5	1346540000
1 roll = 1000 label = 1 Qty. 1 sheet = 60 label = 1 Qty.		

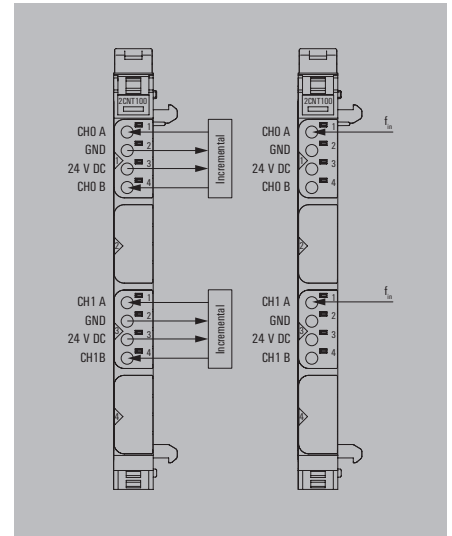

Product standard	IEC 61131-2
EMC	EN 61000
ATEX	EN 60079
UL	UL 61010-2-201
MSIP	MSIP-REM-WMG-1315590000
ABS (American Bureau of Shipping)	
BSH (Federal Maritime and Hydrographic Agency of Germany)	
BV (Bureau Veritas)	
DNV GL (Det Norske Veritas) (Germanischer Lloyd)	
LR (Lloyd's Register)	
RINA (Registro Italiano Navale)	



## Flexible automation of applications

### u-control 2000 for a powerful and compact control system

The powerful u-control 2000 controller is based on a compact design of the u-remote fieldbus coupler - for even greater space savings and maximum flexibility in the implementation of individual automation solutions. It is compatible with the entire u-remote portfolio and offers the possibility to I/O modules directly. Combined with our versatile Engineering tools u-create studio and u-create web unfold their full potential Range of applications.

The u-control 2000 is equipped with an Ethernet based fieldbus and a TCP/IP interface for programming. The controller also has an optional CAN interface. Optionally, communication via the Modbus TCP protocol is also possible. In addition, u-control 2000 has a dual-core ARM-A9 processor and a USB service interface. In addition to the battery-buffered real-time clock, it also has a slot for a MicroSD with up to 32 GB.

In combination with the u-create software tools, u-control enables a maximum of customization.

Entire  
portfolio  
in online  
catalogue

compatible  
with u-create  
software-tools



**Flexible**

Compatible with u-create and u-remote

**Comfortable**

Battery-buffered real-time clock

**Compact**

54 mm slim

**Optional CAN interface**

**Diversity**

Equipped with USB service interface and Ethernet ports

Slot for a MicroSD with up to 32 GB

**Secure**

Security-by-Design Concept



## Automation kit

## Controller - UC20-SL2000-OLAC-EC

- OpenLinux automation controller
- Engineering tool u-create studio
- System supply of 64 I/O modules
- Configurable as EtherCAT master
- 2 x 5 A current path

## UC20-SL2000-OLAC-EC



## Technical data

## System data

Connection type  
max. number of modules  
Configuration interface  
Processor  
Memory (Flash)  
Real-time clock  
Engineering tool  
Field bus protocol

2 x RJ45 plug-in connectors  
64  
Micro USB 2.0  
Dual Core ARM Cortex A9, 624 MHz, 512 Mbyte RAM  
4 GB, 32 GB via microSD  
Battery buffered  
u-create Studio  
EtherCAT

## Supply

Supply voltage for inputs  
Supply voltage for outputs  
Feed current for  $I_{in}$  (input current path), max.  
Feed current for  $I_{out}$  (output current path), max.  
Current consumption  $I_{in}$  (power segment of the field bus coupler), typ.

24 V DC +20 %/ -15 %  
24 V DC +20 %/ -15 %  
5 A  
5 A  
116 mA

## General data

Weight  
Dimensions H x W x D

250 g  
120 mm / 52 mm / 76 mm

## Note

A termination kit (UC20-EBK-ACC) is included in the controller package.

## Ordering data

## Module variants

OpenLinux automation controller (Studio engineering)

## Note

Type	Qty.	Order No.
UC20-SL2000-OLAC-EC	1	2638920000

## Accessories

Type	Qty.	Order No.	
Coding elements	KOSM BHZ5.00	100	1483050000
SD Memory Card	SD-CARD-8GB	1	2684400000
Battery for real-time clock	BATTERY-CR1220-3V	1	2684410000
Termination kit	UR20-EBK-ACC	5	1346610000
Swivel marker	UR20-SM-ACC	20	1339920000
Connection marker for pusher custom printing	PM 2.7/2.6 MC SDR	192	1323700000
Connection marker for pusher neutral	PM 2.7/2.6 MC NE WS	960	1323710000
Module marker for custom printing	DEK 5/8-11.5 MC SDR	100	1341610000
Module marker for neutral	DEK 5/8-11.5 MC NE WS	500	1341630000
Thermotransfer version (Material: Polyester)	THM UR20 GE	1	1429910000
Thermotransfer version (material: polyester)	THM UR20 WS	1	1429420000
Paper version for Laserprinter	ESD UR20 DIN A4 WS	10	1429430000
USB cable (USB A to Micro USB)	IE-USB-A-MICRO-1.8M	1	1487980000

## Engineering software

u-create studio engineering software

U-CREATE-STUDIO	1	2660130000
-----------------	---	------------

## Replacement parts

Plug-in connector unit

UR20-PK-2674520000-SP	5	2665170000
-----------------------	---	------------

## Note

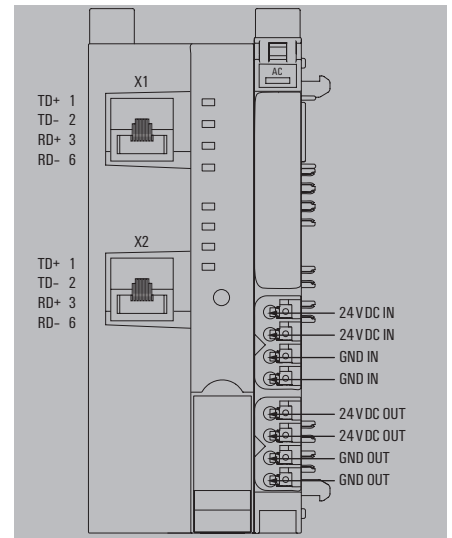

**Controller - UC20-WL2000-AC**

- Automation controller
- Engineering tool u-create web
- System supply of 64 I/O modules
- 2 x 5 A current path

**UC20-WL2000-AC****Technical data****System data**

Connection type  
max. number of modules  
Configuration interface  
Processor  
Memory (Flash)  
Real-time clock  
Engineering tool

**Supply**

Supply voltage for inputs  
Supply voltage for outputs  
Feed current for  $I_{IN}$  (input current path) , max.  
Feed current for  $I_{OUT}$  (output current path) , max.  
Current consumption  $I_{IN}$  (power segment of the field bus coupler), typ.

**General data**

Weight  
Dimensions H x W x D

**Note**

2 x RJ45 plug-in connectors  
64  
Micro USB 2.0  
Dual Core ARM Cortex A9, 624 MHz, 512 Mbyte RAM  
4 GB, 32 GB via microSD  
Battery buffered  
u-create web

24 V DC +20 %/ -15 %  
24 V DC +20 %/ -15 %  
5 A  
5 A  
116 mA

329 g

120 mm / 52 mm / 76 mm

A termination kit (UC20-EBK-ACC) is included in the controller package.

**Ordering data****Module variants**

Automation controller (Web engineering)

**Note**

Type	Qty.	Order No.
UC20-WL2000-AC	1	1334950000

**Accessories**

Coding elements  
SD Memory Card  
Battery for real-time clock  
Termination kit  
Swivel marker  
Connection marker for pusher custom printing  
Connection marker for pusher neutral  
Module marker for custom printing  
Module marker for neutral  
Thermotransfer version (Material: Polyester)  
Thermotransfer version (material: polyester)  
Paper version for Laserprinter  
USB cable (USB A to Micro USB)

Type	Qty.	Order No.
KOSM BHZ5.00	100	1483050000
SD-CARD-8GB	1	2684400000
BATTERY-CR1220-3V	1	2684410000
UR20-EBK-ACC	5	1346610000
UR20-SM-ACC	20	1339920000
PM 2.7/2.6 MC SDR	192	1323700000
PM 2.7/2.6 MC NE WS	960	1323710000
DEK 5/8-11.5 MC SDR	100	1341610000
DEK 5/8-11.5 MC NE WS	500	1341630000
THM UR20 GE	1	1429910000
THM UR20 WS	1	1429420000
ESO UR20 DIN A4 WS	10	1429430000
IE-USB-A-MICRO-1.8M	1	1487980000

**Replacement parts**

Plug-in connector unit

UR20-PK-1334950000-SP	5	2605360000
-----------------------	---	------------

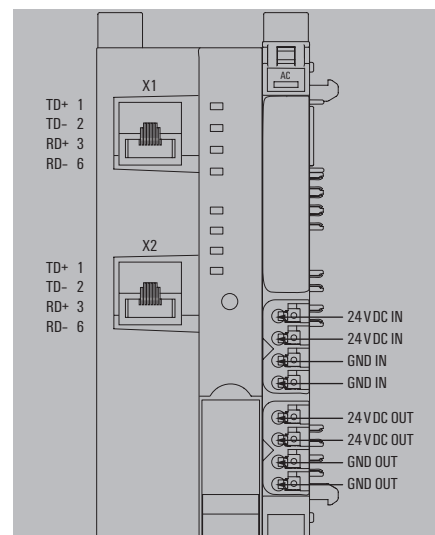
**Note**

## Automation kit

## Controller - UC20-WL2000-IOT

- Automation controller
- Engineering tool u-create IoT
- System supply of 64 I/O modules
- 2 x 5 A current path

## UC20-WL2000-IOT



## Technical data

## System data

Connection type	2 x RJ45 plug-in connectors
max. number of modules	64
Configuration interface	Micro USB 2.0
Processor	Dual Core ARM Cortex A9, 624 MHz, 512 Mbyte RAM
Memory (Flash)	4 GB, 32 GB via microSD
Real-time clock	Battery buffered
Engineering tool	u-create web

## Supply

Supply voltage for inputs	24 V DC +20 % / -15 %
Supply voltage for outputs	24 V DC +20 % / -15 %
Feed current for $I_{IN}$ (input current path) , max.	5 A
Feed current for $I_{OUT}$ (output current path) , max.	5 A
Current consumption $I_{IN}$ (power segment of the field bus coupler), typ.	116 mA

## General data

Weight	329 g
Dimensions H x W x D	120 mm / 52 mm / 76 mm

## Note

A termination kit (UC20-EBK-ACC) is included in the controller package.

## Ordering data

## Module variants

Automation controller (Web engineering)

## Note

Type	Qty.	Order No.
UC20-WL2000-IOT	1	1334990000

## Accessories

Coding elements	KOSM BHZ5.00	100	1483050000
SD Memory Card	SD-CARD-8GB	1	2684400000
Battery for real-time clock	BATTERY-CR1220-3V	1	2684410000
Termination kit	UR20-EBK-ACC	5	1346610000
Swivel marker	UR20-SM-ACC	20	1339920000
Connection marker for pusher custom printing	PM 2.7/2.6 MC SDR	192	1323700000
Connection marker for pusher neutral	PM 2.7/2.6 MC NE WS	960	1323710000
Module marker for custom printing	DEK 5/8-11.5 MC SDR	100	1341610000
Module marker for neutral	DEK 5/8-11.5 MC NE WS	500	1341630000
Thermotransfer version (Material: Polyester)	THM UR20 GE	1	1429910000
Thermotransfer version (material: polyester)	THM UR20 WS	1	1429420000
Paper version for Laserprinter	ESO UR20 DIN A4 WS	10	1429430000
USB cable (USB A to Micro USB)	IE-USB-A-MICRO-1.8M	1	1487980000

## Replacement parts

Plug-in connector unit

## Note

Type	Qty.	Order No.
UR20-PK-1334990000-SP	5	2605350000

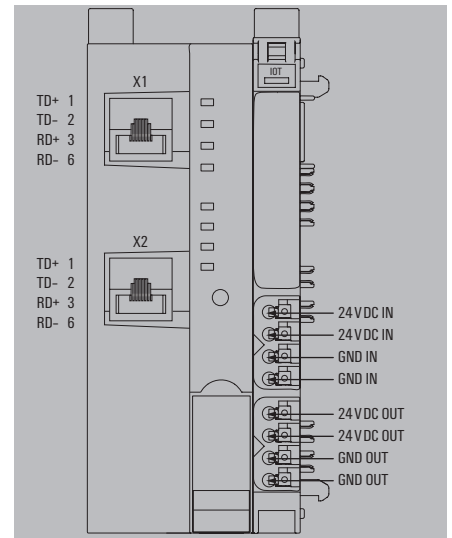



# Flexible implementation of visualization, control and IoT applications

## Reliable industrial PCs for your automation

High-performance IPCs and Panel PCs enable the flexible control, operation and monitoring of machines and systems. u-view IPCs and Panel PCs from Weidmüller are known for their high reliability and are designed for state-of-the-art visualisation, control and IoT applications.

The u-view IPC and Panel PC series use the latest, passively cooled Intel® Atom™, Celeron™, and Core™ i-processors. By selecting from high-quality aluminium housings in various sizes, a wide range of interfaces, and modern operating systems, you can build IPCs that optimally fit your requirements. The Panel PCs close the gap between IPCs and HMIs by combining the high-quality display technology of u-view HMIs with the performance of state-of-the-art hardware.

Long-term available components and highest demands on processing and design make the u-view portfolio the optimal hardware for your future-oriented visualization, control and IoT applications.





#### Flexible application range

u-view IPCs and Panel PCs are perfectly tailored for state-of-the-art visualization, automation and IoT applications and support Windows and Linux operating systems.



**Intuitive thanks to multi-touch**

#### Scaleable performance

The different performance classes provide a broad selection of hardware for an optimal fit to your applications.



#### High-quality finish for industrial use

The sturdy aluminium housings meet the highest quality requirements and enable the passive cooling of IPCs and Panel PCs through intelligent heat management.



**More products in our online catalogue:**  
[catalog.weidmueller.com](http://catalog.weidmueller.com)

## Ultra Compact PC - 1000

## UV20-B-IPC-1011.01

## UV20-B-IPC-1000.01



## Technical data

General data	
Width / Height / Depth	43.4 / 140 / 101.5 mm
Weight	350 g
Protection degree	IP20
Voltage supply	24 V DC (18-32 V DC) isolated
Humidity	80% relative humidity (without condensation)
Operating temperature	0 °C ... +50 °C
Storage temperature	-10 °C ... +60 °C
Approvals	CE, EN 61000-3-2,-3, EN 55022, EN 55024, EN 60950-1, cULus LISTED (UL 61010)
System data	
Processor	Intel Atom® x7-E3950 - Quad Core 1.6 GHz (2.0 GHz Burst)
RAM	4 GB, DDR4, soldered
Operating system	Windows 10 IoT Enterprise LTSC 2019 64bit - Entry
Interfaces in front	2 x Ethernet 10/100/1000 MBit/s (RJ45), 2x USB 3.0, 1x Displayport™
Memory	64 GB m.2 SSD
Note	

## Ordering data

Type	Qty.	Order No.
Ultra Compact PC - 1000		
UV20-B-IPC-1011.01	1	2665800000
Type	Qty.	Order No.
UV20-B-IPC-1000.01	1	2676340000
Note		

## UV20-B-IPC-1011.02



43.4 / 140 / 101.5 mm

350 g

IP20

24 V DC (18-32 V DC) isolated

80% relative humidity (without condensation)

0 °C ... +50 °C

-10 °C ... +60 °C

CE, EN 61000-3-2,-3, EN 55022, EN 55024, EN 60950-1, cULus LISTED (UL 61010)

Intel Atom® x7-E3950 - Quad Core 1.6 GHz (2.0 GHz Burst)

4 GB, DDR4, soldered

Windows 10 IoT Enterprise LTSC 2019 64bit - Entry

2 x Ethernet 10/100/1000 MBit/s (RJ45), 2x USB 3.0,

1x Displayport™

128 GB m.2 SSD

Type	Qty.	Order No.
UV20-B-IPC-1011.02	1	2676350000

## Compact PC - 2000

## UV20-B-IPC-2001.02

## UV20-B-IPC-2001.01



## Technical data

General data	
Width / Height / Depth	54.3 / 185 / 182 mm
Weight	1000 g
Protection degree	IP20
Voltage supply	24 V DC (18-32 V DC) isolated
Humidity	80% relative humidity (without condensation)
Operating temperature	0 °C ... +50 °C
Storage temperature	-10 °C ... +60 °C
Approvals	CE, EN 61000-3-2,-3, EN 55022, EN 55024, EN 60950-1, cULus LISTED (UL 61010)
System data	
Processor	Intel® Celeron® J1900 - Quad Core 2.0 GHz (2.42 GHz Burst)
RAM	4 GB, DDR3
Memory	60 GB mSATA SSD
Operating system	no pre-installed operating System
Interfaces above	2 x Ethernet 10/100/1000 MBit/s (RJ45), 1x USB 2.0, 1x USB 3.0, 1x DVI-D
Interfaces in front	1x Cfast slot
Note	

## Ordering data

Compact PC - 2000		Type	Qty.	Order No.
Note		UV20-B-IPC-2001.02	1	<b>2665810000</b>

Type	Qty.	Order No.
UV20-B-IPC-2001.01	1	<b>2676370000</b>

## UV20-B-IPC-2001.03



48 / 185 / 182 mm

1000 g

IP20

24 V DC (18-32 V DC) isolated

80% relative humidity (without condensation)

0 °C ... +50 °C

-10 °C ... +60 °C

CE, EN 61000-3-2,-3, EN 55022, EN 55024, EN 60950-1, cULus LISTED (UL 61010)

Intel® Celeron® J1900 - Quad Core 2.0 GHz (2.42 GHz Burst)

4 GB, DDR3

120 GB mSATA SSD

Windows 10 IoT Enterprise LTSC 2019 64bit - Entry

2 x Ethernet 10/100/1000 MBit/s (RJ45), 1x USB 2.0, 1x USB 3.0, 1x DVI-D

1x Cfast slot

Type	Qty.	Order No.
UV20-B-IPC-2001.03	1	2676380000

# Industrial Ethernet product line

## Industrial Ethernet switches

### Networking of automation components in a simple and effective way

Switches are the basic coupling elements in Ethernet networks. They connect the Ethernet participants with each other and enable the communication.



#### Unmanaged switches:

- Plug and Play devices for fast networking
- Cost-sensitive entry into industrial networks
- Integration of multiple end devices into one network

#### Product characteristics:

- Sturdy IP30 metal housing
- Compact design
- Fast Ethernet and Gigabit versions with 5 to 24 ports
- Models with copper or fibre optic interface for multimode and singlemode
- Redundant power supply
- Large variety of approvals such as CE, FCC, cULus, Class1 Div.2, ATEX, DNV-GL

#### Managed switches:

- Ideal for managing complex networks or creating redundancy
- Web-based configuration via a simple and intuitive user interface
- Extensive control mechanisms for data distribution and bandwidth management

#### Product characteristics:

- High-quality metal housing in IP30
- Value Line switches for configurable access networks
- The right solution for every requirement: from light-managed to fully managed for demanding network requirements
- Fast redundancy mechanisms
- Fieldbus protocol supports PROFINET conformity class B and Ethernet/IP.
- Large variety of approvals such as CE, FCC, cULus, Class 1 Div. 2 or ATEX Zone 2, DNV-GL etc.

### Industrial security router

The Industrial Ethernet router from Weidmüller makes sure that different networks work together in unison and with the highest level of security. It also offers the possibility to reduce your service costs through remote maintenance.



#### Product characteristics:

- High-performance industrial security router with integrated stateful packet inspection firewall
- Separation of networks, e.g. machine network and production network
- Mobile phone connection via 4G, fully backwards compatible
- Secure remote access with VPN via open standards such as OpenVPN and IPsec or simply via the u-link Remote Access Service
- Class 1 Div. 2 or ATEX Zone 2, DNV-GL etc.
- Also suitable for ship networks, port facilities or off-shore applications thanks to DNV-GL approval
- 1:1 NAT for easy integration of systems into a network

### Media converters and protocol gateways

Solutions for trouble-free data transmission over long distances for Ethernet and serial data and their conversion.



#### Product characteristics:

- Integration of serial devices into Ethernet networks
- Use of Ethernet over long distances and in EMC-critical environments
- Transmission of serial signals over long distances
- Conversion from Modbus RTU to TCP

### Industrial WiFi

Wireless industrial devices that serve as access points, bridges or clients for wireless Ethernet connectivity.



#### Product characteristics:

- Industrial WiFi devices for reliable wireless networking
- Flexible use as access point, bridge or client
- Client routing mode for separating LAN and WLAN network
- Up to 300 Mbit/s transmission rate
- Optimised security through encryption, Radius server and packet filter



More products in our  
online catalogue:  
[catalog.weidmueller.com](http://catalog.weidmueller.com)

# Integration of existing components into IoT networks

## Complete application representation for the IoT gateway

In order to be able to use all the advantages of Industrial IoT, the consistent monitoring of all system components is required in addition to networking. We offer you a convenient retrofit solution which, as well as recording energy and machine data simply and with flexibility, also handles the pre-processing and storage of this data as well as its forwarding to your own IT or cloud systems via network or mobile phone. Using the gateway as an edge computer helps reduce the load on the cloud, simplify data processing and improve overall equipment effectiveness (OEE). Thanks to the combination with powerful data analysis tools such as ResMa, which are also available as cloud services, we can provide you with all the necessary system components from a single source.

### The particular benefits:

- Cable savings, since the sensors are connected directly to the measuring instrument
- Ready-to-use data logger with standard Modbus interfaces
- The pre-processing of data in the gateway reduces cloud expenses



Monitoring and analysis of the system status, e.g. with regard to the total energy consumption with a single web-based application

Transfer of system data to public cloud platforms

Use of a multifunctional measuring instrument with extensive interfaces

Collect data from a variety of field sensors and devices

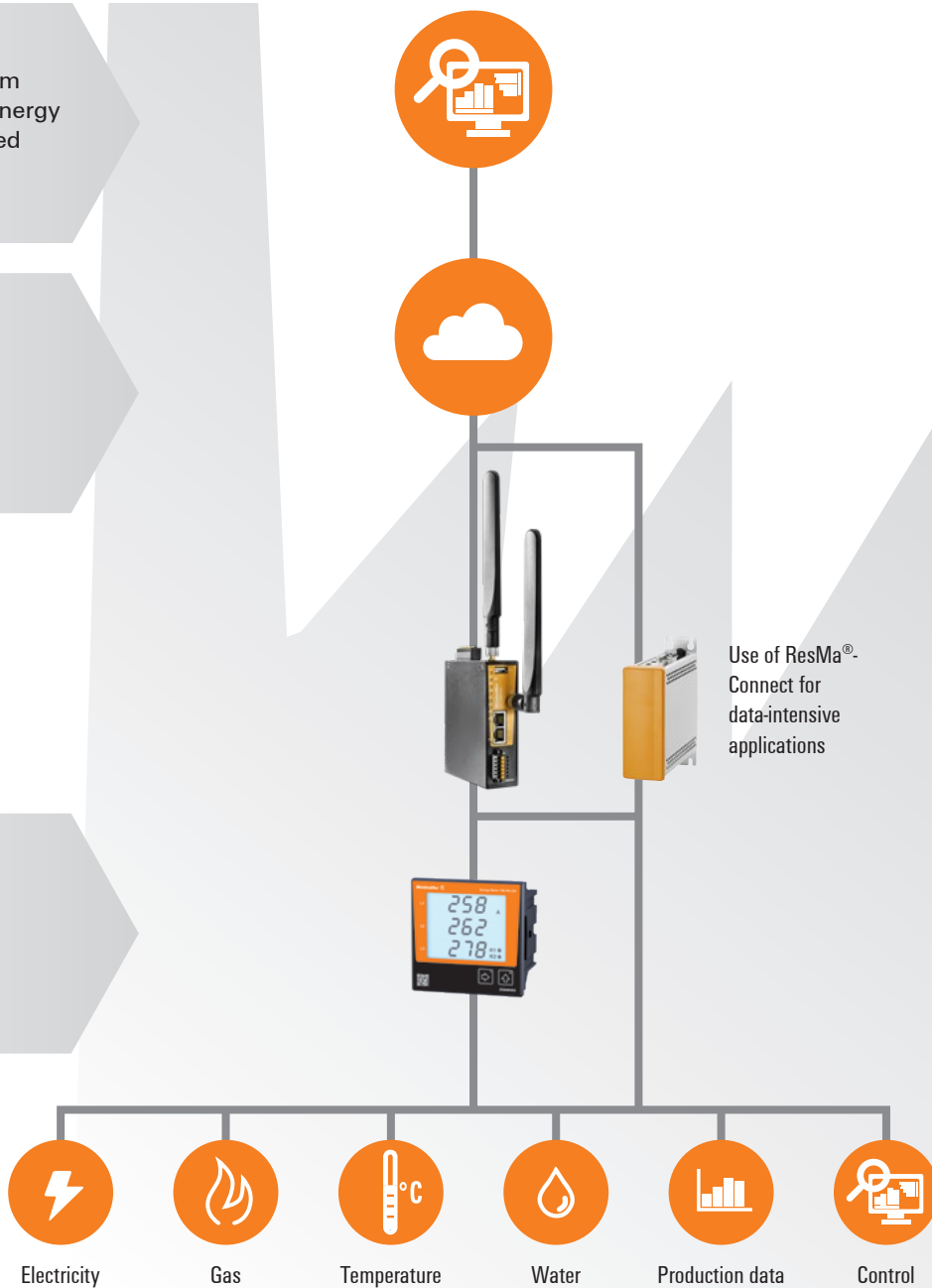

Use of ResMa<sup>®</sup>-Connect for data-intensive applications



More products in our online catalogue: [catalog.weidmueller.com](http://catalog.weidmueller.com)

- Enables machine data acquisition and provides access to field devices and PLC's via various protocols and interfaces
- interfaces to your own IT systems as well as to common cloud systems
- data traffic reduction through preprocessing on edge via the open IoT standard Node-RED
- Secure and easy remote maintenance with Weidmüller u-link remote access Service
- Integration of most common communication interfaces in small design
- D1Open programming platform Node-RED with strong community support



**Technical Data**

Interfaces	
Digital inputs	1x, 19.2-28 V high; max. 1 A
Digital outputs	2x, >10 V high, <3.6 V low; max. 30 V DC
Ethernet ports	2
RJ45 ports	10/100BaseT(X), auto negotiation, Full-/halfduplex mode, Auto MDI/ MDI-X port
Serial port	1x RS232/RS485
USB port	1x USB 2.0 (Type A; max. 500 mA)
System data	
Real-time clock	Capacity buffered (max. 5 days)
Processor	Dual Core ARM Cortex A9, 600 MHz
Memory (Flash)	4 GB
Memory (RAM)	1 GB, DDR3
VPN	
u-link	OpenVPN-based remote access service via the Weidmüller u-link cloud
Technical data	
Housing main material	Metall
Weight	412 g
Dimensions W x H x D	35 x 125 x 105 mm
Protection degree	IP20
Type of mounting	DIN rail
Environmental conditions	
Operating temperature, max.	60 °C
Operating temperature, min.	-20 °C
Humidity	5 to 95 % (noncondensing)
Storage temperature, max.	85 °C
Storage temperature, min.	-40 °C
Power supply	
Supply voltage	24 V DC
Voltage supply range	Voltage type DC Voltage, min. 19.2 V Voltage, max. 28 V
Current consumption	24 DC   0.24 A
Reverse polarity protection	Yes

Approvals	
EMC standards	EN 61000-6-3, EN61000-6-2
Shock	according to IEC 60068-2-27
Vibration	according to IEC 60068-2-6
ROHS	Conform
Classifications	
ETIM 6.0	EC001099
ETIM 7.0	EC001099
eClass 9.0	19-17-01-00
eClass 9.1	19-17-01-00
eClass 10.0	19-17-04-90
Guarantee	
Time interval	3 years

Ordering data			
Version	Type	Operating temperature	Order No.
IoT Gateway, Fast Ethernet, IP20, -20 °C...60 °C	IOT-GW30	-20 to +60 °C	<b>2682620000</b>

# Software

<b>Software</b>	Energy Suite	B.2
	ecoExplorer go	B.4
	u-create ResMa®	B.6
	u-create studio	B.18
	u-create web	B.19
	u-create PROCON-WEB	B.22
	u-link	B.24

# Data processing for Energy Management and energy analytics

## Weidmüller Energy Suite

### B

Data processing is becoming increasingly important in an industrial context. We are your partner for all matters relating to software application matters, and will provide you with suitable software solutions as necessary. With our comprehensive expertise, we ensure a smooth interplay in digitalised industry – from the recording of data at the field level and distribution using our industrial ethernet components through to comprehensive data processing in the fields of industrial analytics and Energy Management.



Industrial software solutions need to have a large number of specific properties in order to provide the greatest possible benefit. We will advise you on the selection and application of your software with our broad expertise. The focus for us is on the following factors:

**Availability**

Our high standards of quality guarantee error-free data processing, a high level of availability and long-term benefit.

**Security**

With all of our projects for customers we tackle the growing danger of attacks from hackers with a particularly thought-out approach. In this way we ensure the greatest possible security before, during and after implementation.

**Data storage**

Our software solutions allow you to reliably store data within your own network without needing to rely on cloud-based services.

**Scalability**

The scalability of our software solutions makes it possible to adapt the growing demands of your company at any time.

**User-friendliness**

Well thought-out and practical operation in the field plays a particularly important role for us. We focus on operating concepts that are tailored precisely to the location of use, and promote efficiency and productivity.



# Conveniently record and clearly display measurement data

## ecoExplorer go simplifies parameterisation and visualisation

B

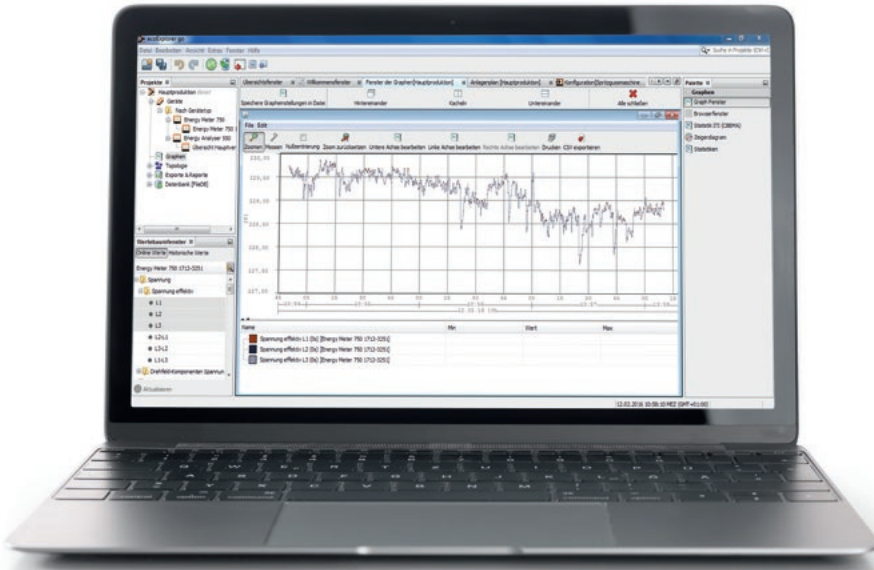

### Quick commissioning

The user-friendly interface of ecoExplorer go allows quick connection and configuration of the measurement devices.

With the ecoExplorer go, you can easily create a commissioning report that can be used to carry out a connection check, thereby verifying the correct functioning of the devices.

### Quick insight

For an efficient energy management, the further processing and evaluation of energy and measurement data for the power quality is of key importance. ecoExplorer go enables initial analysis of the energy grid.

### Power quality report

With the ecoExplorer go and our EA750, you can monitor the voltage quality of the whole system, and with the report generator you can generate network quality reports according to PQ standards like EN 50160 or EN61000-2-4.

### Hardware-Requirements

- CPU: x86\_64 Dualcore,  $\geq 2,0$  GHz,  $\geq 8$  MB cache
- Min. 8 GB Memory
- Min. 16 GB free hard drive space (demand depends on data retention)

### Data storage

- Live visualisation of measurement data
- Reading the device memory (if available)
- Creation of CSV files

### Fielddevice-Configuration

- Local backup of the field device configuration
- Graphical configuration of Energy Meters / Energy Analysers
- Management of the field device memory (when available)

We reserve the right to make technical changes.

The visualisation of energy consumers is a central principle to make production sites more efficient.

Many of our energy measurement devices have a very simple user interface for reasons of clarity to allow the display and parameterisation of the measured data directly on the device. ecoExplorer go is a PC-based software which allows you to access your devices quicker and more simply and conveniently than before. Thanks to the intuitive user interface, users can configure the measurement devices quickly and easily and display the measured data clearly.

ecoExplorer go has been tailored to the use of measurement equipment in the energy sector. This guarantees that it provides optimum performance in practice.



**You can find the download  
for the software ecoExplorer go here:  
[www.weidmueller.com/ecoexplorergo](http://www.weidmueller.com/ecoexplorergo)**

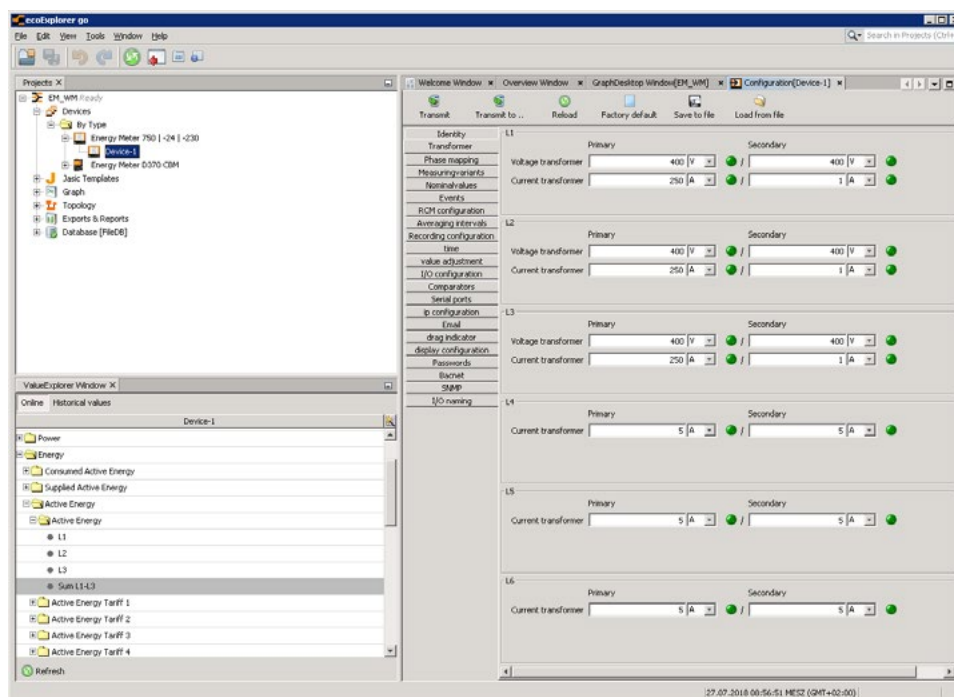

# ResMa® - Energy management for industry

## System features



### Modular design

Starting with the compact entry-level system through to the complex EnMS Suite, the functionality can be adapted to the requirements.



### Scalable

The quantity structure can be very widely scaled with regard to data points and simultaneous users.



### Installed or Cloud

Local installations on compact IPCs or in virtual machines are supported, in the same way as a Cloud solution.



### Any measurement technology

Any measurement and control technology usable in the system for data acquisition.



### Across locations

By decoupling from data acquisition, worldwide distributed installations can also be coupled via modems.



### Multilingual

Multilingual structure based on Unicode for worldwide distributed applications.



### Individual rights

User-specific rights to define the allowed functionality and the viewable data.



### Integrable in IT

Connectors for data exchange with ERP/ MES systems or with other databases.



### ISO 50001 certified

Certified by TÜV-Süd and listed by the German Federal Office of Economics and Export Control (BAFA).



### Branding

Option of customer-specific adaptations and branding for OEM customers.

## System variants



### ResMa® Compact

Cost-effective entry-level solution, ready installed on a compact industry PC for installation in the control cabinet or on a DIN rail. Connection of counter with Modbus RTU (RS485) or Modbus TCP counters from various manufacturers. Unrestricted evaluation options and reporting system.



### ResMa® Server

Scalable solution for installation on a dedicated or virtual server. No restriction of the functional scope and extensive options for integration of external systems. PlugIn concept for customer-specific extensions.



### ResMa® Cloud

Use of ResMa® on a rental basis as a Cloud solution. Quick start of in-house energy management system, also across locations without setting up an internal infrastructure. Fully scalable and rental price credited against a purchase licence.

### Certification and funding

ResMa® is TÜV-certified and BAFA-listed. So you have the assurance of a solution compliant with ISO 50001 requirements and for claiming funding options.



Federal Office  
for Economic Affairs  
and Export Control



## Modular design

### Open and powerful solution

#### B

ResMa® effectively supports all tasks for an efficient and active energy management system and thus significantly reduces the personnel expenses necessary.



Data acquisition



Energy analysis



Reports

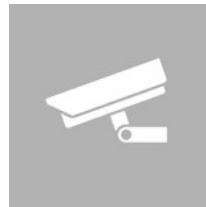

Monitoring



Peak load management



Calculated parameters



Visualisation



Administration



Cockpit

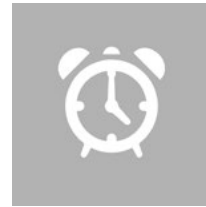

Alarming



Documentation

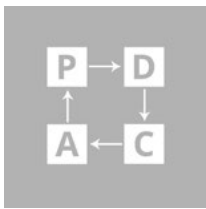

PDCA cycles



Energy forecast



Tariffs



IT integration

Energy management according to ISO 50001 means continuously checking and optimising energy efficiency. This perpetual task calls for the maximum support from a powerful system, which takes care of monitoring and analysis largely independently. The generation of informative energy performance indicators, EnPIs (KPIs), while taking into consideration production parameters and their monitoring using energy monitoring, forms the basis for reducing daily monitoring expenses.

With the overview of consumption and the energy balancing on which this is based, approaches for expanding the measuring equipment or for specific saving potential can be determined, which are documented in the PDCA cycle and the result checked.

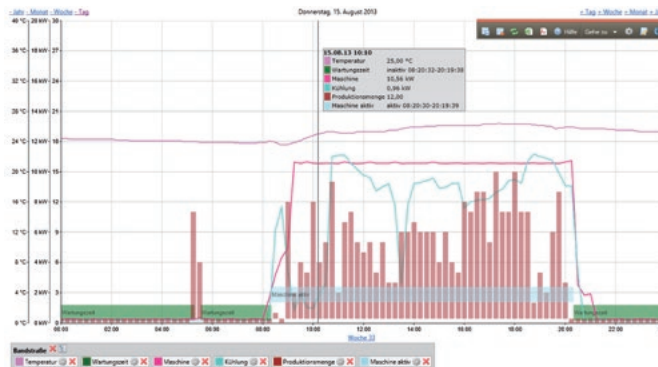

Interactively adaptable charts help provide the detailed analysis; for every situation they allow the optimal representation of correlations and can be saved for further editing, also by other colleagues. Customable reports balance energy and KPIs from production in a clearly arranged form.

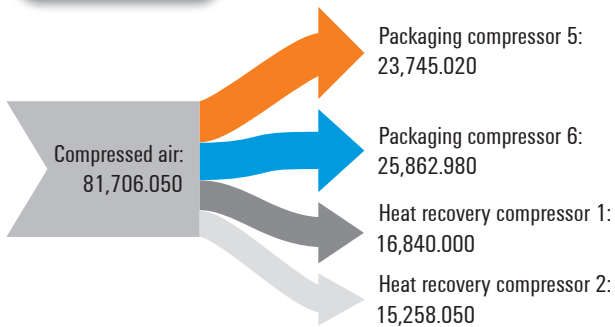

# ResMa® System structure

## B

**ResMa® is an open solution that supports all measurement systems and industrial controllers and can grow with your requirements.**

### Weidmüller GTI Software supports you in integrating the EnMS

With ResMa®, Weidmüller GTI Software offers not only a comprehensive software solution for energy management in accordance with ISO 50001, but also the necessary support for integration in existing automation technology, control technology or building automation and in connecting to the company IT. Customer-specific requirements with regard to energy planning, peak load optimisation or on-demand control can be tailored to the concerns of the customer through adapted support.

### Energy consultant



Workplace

### Service partner



Smartphone



Notebook

### Site 1

- S5/S7 RFC 1002/1006
- Ethernet/IP
- Beckhoff ADS
- Modbus-TPC
- B&R PVI
- 3S SYMARTI/Gateway
- OPC, OPC-UA
- ...

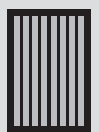

Data loggers



Controls

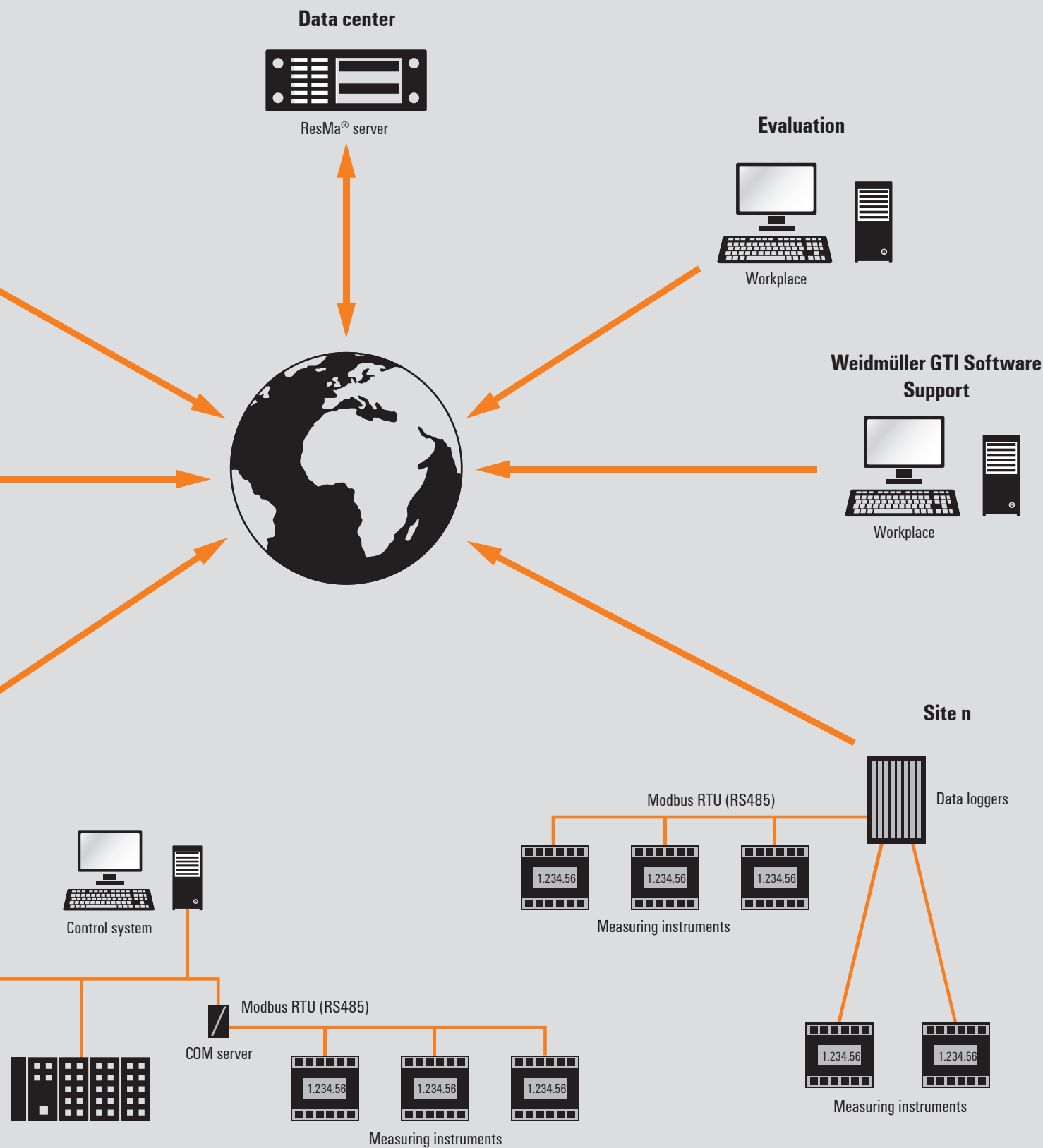

# Inexpensive entry-level solution for an expandable EnMS

## B

Entry into energy management should involve as few resources as possible before initial findings are established in order to justify a more extensive expansion. Therefore, Weidmüller GTI has developed an inexpensive entry-level compact variant of the more comprehensive ResMa® solution, on the basis of industrial hardware. It can be used to record and evaluate conventional measurement counters with the standard Modbus RTU or Modbus TCP interfaces. The entry-level solution contains all the functions required by the TÜV (German technical inspectorate) for an EN 50001-compliant energy management system.



**Federal Office  
for Economic Affairs  
and Export Control**

### Simple recording of energy data

ResMa® Compact offers an integrated hardware and software solution for recording and evaluating energy data. You can connect up to 250 serial-networked measuring instruments to a compact and robust IPC via RS-485 interface and Modbus RTU protocol. Alternatively, you can connect measuring instruments via a TCP/IP network.

The ResMa® software installed on the Compact supports easy configuration of the connected devices and performs ongoing recording of measured values. Comprehensive functions allow for the convenient evaluation of the recorded data right through to complex energy reports. The open solution can be expanded in terms of its functional scope in order to create a complex, cross-location energy management system of the highest performance class.

## Comprehensive evaluations and reporting

With the ResMa® Compact and the ResMa® software, energy data can be displayed visually. ResMa® uses the data recorded by the Compact system and makes it available in different consumer overviews in the form of a diagram, value table, pivot or report.

ResMa® offers a comprehensive environment for the administration of the system. It enables the user to perform a meaningful evaluation and analysis of all recorded measured values while also providing the necessary transparency for optimisation. The integrated documentation functions support the work of the energy manager and allow for the integration of additional employees for the analysis or implementation of improvement measures. The high-performance software solution can be deployed in any sector.

It can be used to automatically record, visualise, analyse and optimise all relevant consumption data, be it relating to current, active power, reactive power and apparent power or gas, water and heat.



**Administration**  
of locations,  
measuring points,  
consumers,  
service partners



**Administration**  
of user rights and  
user groups



**Electronic**  
and manual recording



**Import & export**  
functions



**Testing**  
and optimisation  
using interactive  
documentation



**Evaluation**  
of energy data via  
interactive charts and  
pivots



**Evaluation**  
via reports generated  
online



**Evaluation**  
via energy key figures  
created online



**Monitoring**  
of faults



**Upgradeable**  
to an extended range  
of functions

# ResMa® Compact

## System structure

### B

The user interface is built as a web application and can be used by up to three users at the same time per web browser, without the need to install any software.

The ResMa® system is mounted on the mounting rail in a control cabinet and is supplied with 24 Volts. A network interface is used for integration into the company network in order to evaluate the energy data. A second network interface and the integrated RS485 interface are used to connect network-compatible measuring systems.

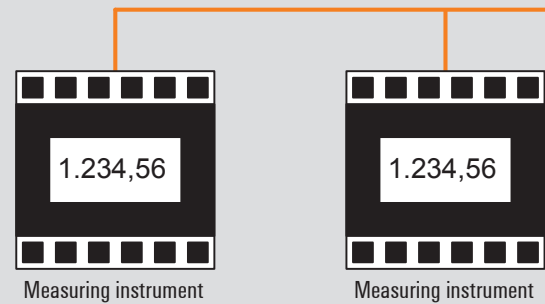

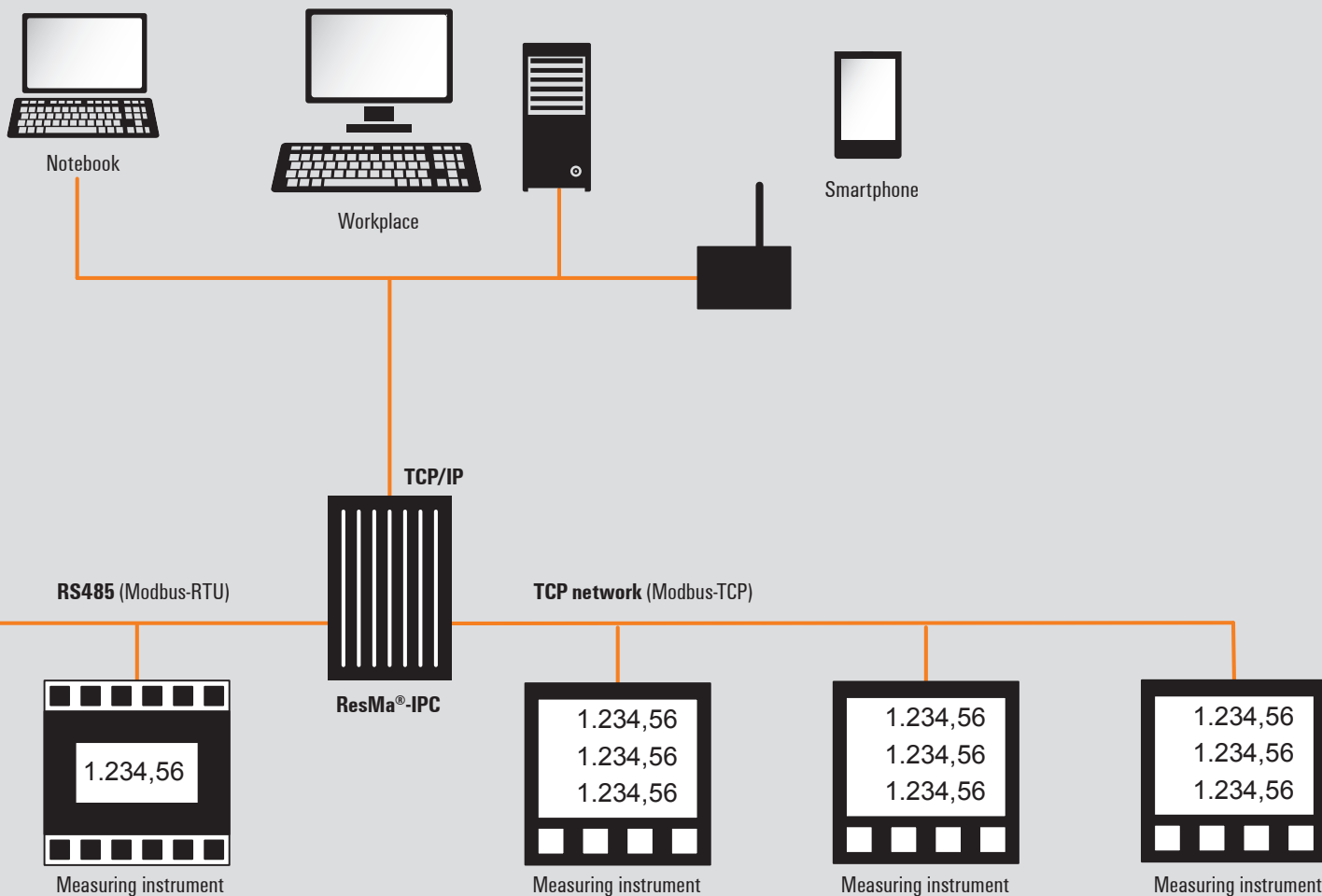

# TÜV certified

## B

ResMa® has been tested and certified by TÜV-SÜD in terms of the DIN/EN 50001 requirements. This guarantees that all the requirements of an eligible EnMS are met. The ResMa® is therefore also included in the Bafa list as an EnMS, as the basis for the application for subsidies.



### Technical data and system variants

#### Hardware:

- Fanless IPC
- CPU: Celeron J1900 (4x 2.0 GHz, to 2.42 GHz burst)
- Main memory: 4 GB
- Mass memory: SSD with 64 GB
- Interfaces: 2x LAN RJ45 1000 Mbit/s, 2x COM (1x 24VDC, 1x RS232/422/485), 1x USB 3.0, 1x USB 2.0, 1x DVI-D
- Power supply: 18 ... 32 V, less than 25 Watt (must be supplied externally)
- Dimensions: 182 x 185 x 48 mm
- Operating system: Windows 10 IoT Enterprise 64 bit

#### Software:

- ResMa® Version 3.1 compact, 3 users
- SQL database (Microsoft SQL Server 2017 Express)
- ResMa® Direct Connect for Modbus RTU and Modbus TCP
- Configurator for ResMa® Connector
- Upgrade available for extended functional scope and for additional interfaces

## Constant view of energy data

<b>Web interface</b>	ResMa® is accessed via a web browser (up to date Chrome, Edge, Firefox). Directly within the network or the company's Intranet, via VPN outside of the company network.
<b>User rights</b>	Personal log-in is required in order to use ResMa®. Each user is assigned individual rights and access options.
<b>Dashboard</b>	The Dashboard is the home page of the ResMa® interface. Usually, the displays that are frequently viewed by the user are selected individually for the dashboard.
<b>Object tree</b>	The object tree illustrates all the data points that are configured in the system in a tree structure. The user can switch between viewing and editing mode. Individual data points can be moved via drag & drop, added to a specific structure point for positioning or edited.
<b>Charts and pivots</b>	The display options for charts and pivots can be individually adapted to various forms for each evaluation. Individual data points are moved via drag & drop to the chart or the pivot table and enable the depiction of several curves, as well as a comparison of the same curve across different time periods (before-and-after comparison). All charts and pivots can be exported as an Excel file, a PDF document or saved as a profile.
<b>Comments</b>	In order to highlight any anomalies in the curve progression, selected values can be commented upon and highlighted in colour in the diagram.
<b>Documentation</b>	Using the interactive documentation, anomalies can be directed at employees or service partners via a text field enabling the sharing of information and tasks. This provides extensive collaboration support with the advantage of being able to access the stored documents directly via a link to the diagram concerned.
<b>Derived values</b>	Derived values are calculated values and consist of a formula. To illustrate a derived value, formula parameters can be selected directly from the object tree via drag & drop and specified at an explicit structure level in the object tree.
<b>Limit monitoring</b>	Limit value monitoring can be added for each measured value, with the criteria min, max, day, time and alarm.
<b>Online report generator</b>	Derived values are calculated values and consist of a formula. To illustrate a derived value, formula parameters can be selected directly from the object tree via drag & drop and specified at an explicit structure level in the object tree.

# Automate with a customized open platform

## u-create studio - the new standard for Codesys and C/ C++ engineering

u-create studio enables flexible and modular programming within your application and provides simple configuration and diagnosis of your system. An OPC-UA server is also available for standardized M2M communication.

Thanks to the open Linux architecture, u-create studio is a particularly flexible automation system that gives you a multitude of options for the individual installation of software modules. IEC 61131-3-compliant programming based on CODESYS Version 3 has proven its worth, especially proven. Additionally u-create studio offers object-oriented programming with C/C++ environment. Powerful debugging and a trace tool support fast error analysis during programming. The fieldbus masters EtherCAT and Modbus TCP Master as well as CANopen are also implemented. u-create studio is the optimally coordinated engineering tool for our u-control 2000 controller.

### Your special advantages:

- CODESYS V3.5 engineering environment according to IEC 61131-3
- Additional programming option in C / C++
- Powerful debugging
- Integrated fieldbus master (EtherCAT, Modbus TCP Master and optional CANopen)

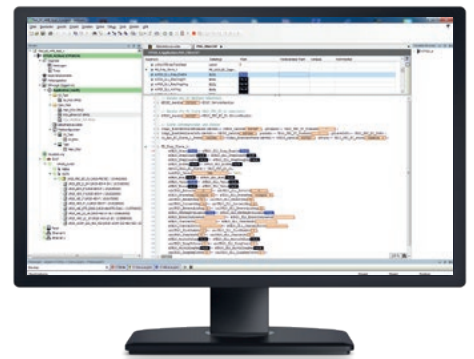

Type	Operating system	Configurable target systems	Software extensions	Order No.	Qty.
U-CREATE-STUDIO	Windows 7, Windows 10	u-control studio hardware	OPC-UA server, Visualisation with u-create PROCON-WEB	2660130000	1

# Future-proof automation for intelligent production

## Innovative control system with platform-independent u-create web engineering tool

Worldwide networking, growing data exchange and customer-specific production require more flexible automation solutions. With u-create web, we provide plant and machine manufacturers with open, web-based and safe control software for the automation of small and medium-sized plants.

u-create web is a web-based engineering software for configuration, system parameterization and programming according to IEC 61131-3. The software is installed directly on the hardware and requires no further installation on a computer. This means that the software can be used as an engineering platform independently of the hardware and operating system. The integrated smartvisu enables visualization of the project within programming. The range of functions can be extended by additional software apps (e.g. OPC UA server/ client module; u-create PROCON-WEB module; etc.). Due to the integration of Node RED, u-create web is also suitable for tasks in Industrial IoT and thus combines both disciplines in one housing.

u-create web in combination with the u-control 2000 controller and the I/O system u-remote the optimal automation solution for your plant.

### Your special advantages:

- Web-based engineering software
- Platform- and device-independent programming via web browser
- Programming standard according to IEC 61131-3
- Use of standardized web technologies such as HTML5



# Programming and communicating in the Cloud

## Node-RED integrated in u-create web for optimal IoT communication

The requirement of modern plants is not only the safe control, but also the safety, to send machine data directly to a cloud. u-create web offers in combination with the Node-RED module the possibility to obtain sensor information of u-remote I/O modules and transfer them to the cloud via MQTT or AMQP.

The data can be sent directly to the cloud via Node-RED. The web-based software environment of u-create web is device- and platform independent. The Security-by-Design concept guarantees a high safety standard.

u-create web with integrated Node-RED module is cross-platform. and can be used with any common browser, the HTML5, CSS and JavaScript supported.

The cloud providers Microsoft Azure, IBM Cloud and Amazon aws are supported. The Node-RED application is easily accessible via the web server of the u-control 2000 and is compatible with our u-remote I/O modules.

### Your special advantages:

- Web-based software
- Platform- and device-independent programming via web browser
- Future-proof thanks to the use of standardized web technologies such as HTML5
- Intuitive implementation of IoT applications thanks to Node-RED





# Forward-looking flexibility through web-based visualisation

## u-create PROCON-WEB – the scalable and platform-independent HMI software

The growing integration of machines and systems places entirely new demands on HMI software. Easily scalable and platform-independent visualisation solutions ensure maximal flexibility and guarantee the availability of all relevant machine data on site.

u-create PROCON-WEB simplifies project planning with dynamic, multi-touch capable visualisation solutions for your automation. The integrated web server allows the use of different HTML5-capable clients without the installation of additional software. The extensive portfolio of communication drivers allows flexible integration into existing or new machines and systems.

u-create PROCON-WEB is integrated on u-control hardware too and together with u-view touch panels enables highly functional automation solutions from a single source.

### Your special advantages:

- Web-based and platform-independent
- Dynamic user interfaces with adaptive design
- Full compatible to our u-control controls, including attractive license concept
- Comprehensive portfolio of drivers for access to the controllers of all established offerer
- Easy integration of different languages through Unicode
- Efficient engineering due to object-oriented layout/container and Class/Instance Concepts
- Fine-grained user and rights management





## u-link remote access service - one tool for all cases

### Extended functions for convenient remote access management

## B

The remote maintenance of machines and systems is often complex and time-consuming. In addition, there is demand for a targeted and secure functional connection to the associated IT systems. For many users, these two challenges are a major obstacle to the worldwide connection of systems.

u-link guarantees quick and secure access to machinery and equipment while enabling the efficient management of production facilities, user clients, access rights or firmware versions. The intuitive u-link web portal can be quickly and easily configured and adapted to specific processes without expert knowledge. Secured servers in Europe provide an online platform that ensures conformity between different IT systems when performing remote maintenance.



#### Customised system management

u-link can be used to manage users, groups and their access rights based on individual requirements, such as a group assignment or access rights for production plants.

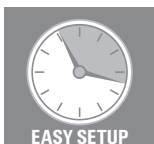

#### Reduced configuration effort

Thanks to the intuitive interfaces, routers and clients can easily be connected without the need for any in-depth IT expertise, which allows for the quick linking of multiple machines to the cloud service.



#### Secure remote maintenance and remote diagnostics

Machines and plants can be accessed remotely via a secure VPN connection, regardless of where they are in the world. The high level of availability of the servers means that you have secure access to your production facilities at all times.



#### Status monitoring and status reports

With Weidmüller Heartbeat, router availability can be reported to u-link, allowing for status monitoring and reporting of the installed router.



[u-link.weidmueller.com](http://u-link.weidmueller.com)

**Plant operators 3**

**Plant operators 1**

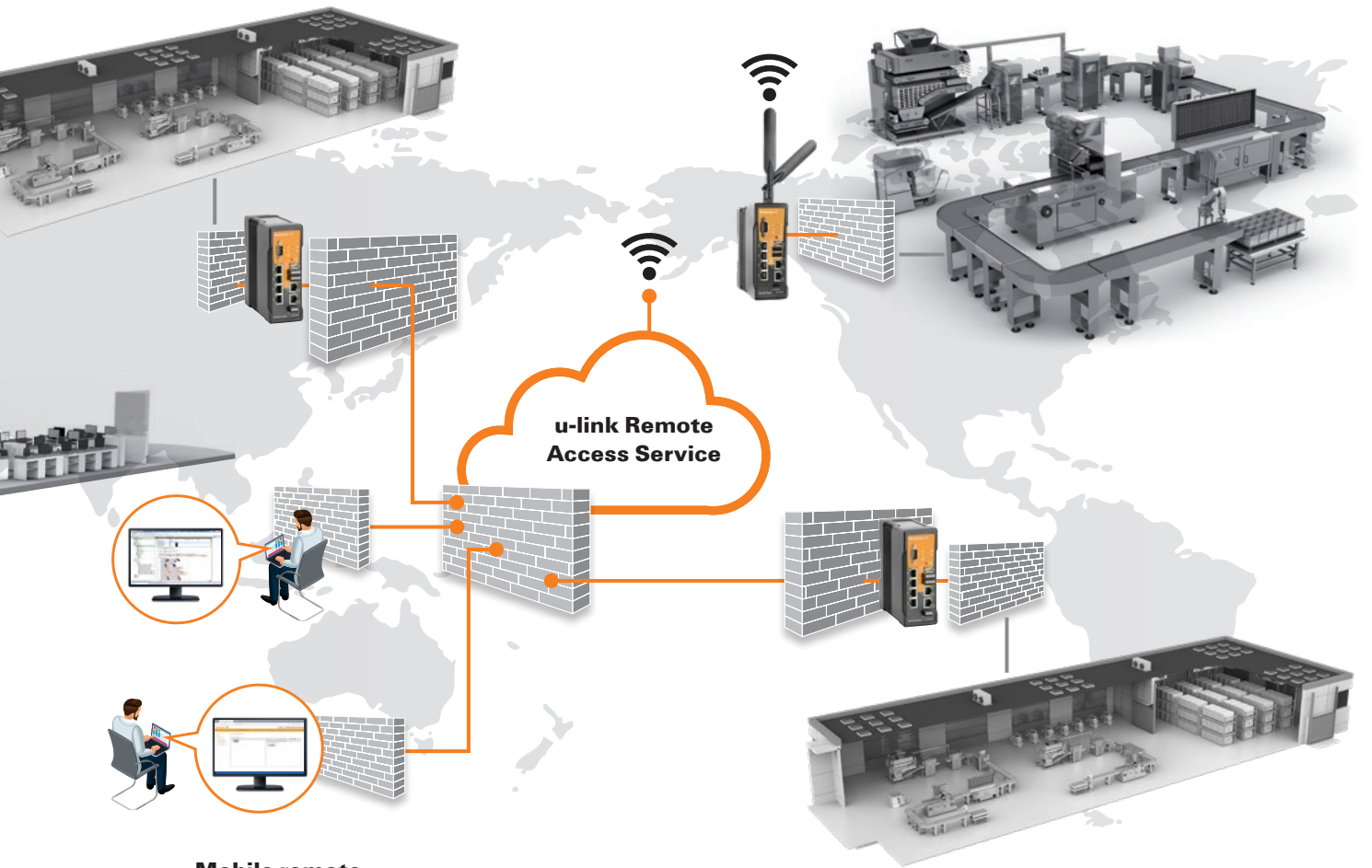

**Mobile remote access of the manufacturer**

**Plant operators 2**



# Service

---

<b>Service</b>	Modular Energy Management solutions for your production	C.2
	Diagnosis audit for the introduction of ISO 50001	C.3
	Energy audit DIN EN 16247-1	C.4
	Energy data acquisition system check	C.5
	Service and support	C.6

---

# Modular Energy Management solutions for your production

## Services for your success

**C** As an experienced Energy Management team, we offer a comprehensive range of tailored services alongside the hardware and software components described. In doing so, we help you to achieve greater energy-efficiency as well as compliance in accordance with ISO 50001.

It goes without saying that the support we provide you is unique and tailored to your company in the form of an energy-efficiency consultation as well as planning all the way through to the integration of your management system.

On request we will support your audits and assist you with applications. We are also happy to support you as an external Energy Management agency.



Our portfolio of services is specific to each country. Please feel free to contact your local Weidmüller team if you have any questions.



# Diagnosis audit for the introduction of ISO 50001

## Systematically reduce your energy consumption and costs!

### Optimise your energy costs!

In accordance with the German laws governing the expansion of renewable energies (EEG), the taxation of power and energy, and energy services and other energy-efficiency measures, large companies have been required to provide DIN EN ISO 50001 (energy management) or EMAS (environmental management) registration since 2015 at the latest in order to benefit from tax relief or an EEG subsidy.



### Challenge

In order to introduce an energy management system pursuant to ISO 50001 effectively and efficiently you need to know where you stand. The interesting question when introducing an energy management system is the extent to which you would already comply with standards if you were to continue to operate as you have been. We have developed a standards-based diagnosis audit in order to answer this question.

### We provide you with a solution!

The informative diagnosis audit gives you a complete project plan for introducing an energy management system pursuant to DIN EN ISO 50001 at your company. Experienced auditors identify cases of non-compliance and weaknesses, and a detailed timeline with information on work packages and internal and external workloads provides you with a basis for a thorough cost/benefit analysis.

### Service specifications

The following services are included:

- Conducting a diagnosis audit in order to optimise your management system, particularly with respect to your external certification in accordance with ISO 50001
- Identification of cases of non-compliance and weaknesses by experienced auditors
- Preparation of a thorough audit report with concrete recommendations for successful certification
- Planning of work packages

### Overview of the most important services

1. Preparation of stock-taking
2. Determination of the production and organisation structure
3. Reviewing management documents
4. Documenting the energy structure
5. Defining potential balance sheet and system thresholds
6. Clarifying responsibilities
7. Determining the workload required to introduce an EnMS
8. Producing a project plan
9. Coordination of work packages
10. Providing information regarding potential subsidies

## Energy audit DIN EN 16247-1

### Short-term reductions in energy consumption thanks to an energy audit

#### Challenge

C

With the exception of small and medium-sized enterprises (SMEs), since 2015 all companies have been required to introduce an energy audit pursuant to EN 16247-1 or an EnMS in accordance with ISO 50001 or EMAS. An energy audit pursuant to DIN EN 16247-1 has also been mandatory for SMEs in the manufacturing sector since 2013 in order to receive tax relief.

The energy audit is an important tool for identifying measures to improve energy-efficiency and reduce energy-related costs. Determining how much energy is consumed and where within the company also reveals where consumption could potentially be reduced. The economic benefit of the energy audit is therefore not to be underestimated. Weidmüller can help you conduct an energy audit in accordance with the applicable standards in order to improve energy-efficiency at multiple locations.



#### Service specifications

The purpose of the energy audit is to identify energy-efficiency measures and interdependencies within production. The cost-effectiveness of individual, relevant measures is also calculated.

The following services are included:

- Detailed planning of the itinerary for the audit, with an inspection of the relevant areas or departments and an audit of the documented information
- Systematic investigation of energy usage and consumption
- Description of the audit findings and evaluation of potential courses of action
- Proof of changes in efficiency and the use of energy

#### The energy audit is broken down into the following steps:

1. Kick-off meeting
2. Data input
3. Field assignment
4. Analysis
5. Report
6. Wrap-up meeting



Contact us for a quote regarding your pending energy audit – [energy@weidmueller.com](mailto:energy@weidmueller.com)

# Energy data acquisition system check

## Lay the foundation for energy-efficiency now

### Challenge

Would you like your company to be more energy-efficient? Is certainty with respect to planning and investment important to you when it comes to measuring your energy data? Then an individual initial energy data input consultation is for you.

### Trust Weidmüller

Weidmüller's energy management team comprises leading energy consultants, management representatives and auditors for energy management systems.

Countless errors can arise when selecting measuring technology, from interfaces through to monitoring software. We recommend courses of action.

As part of the system check we assess your options for subsidies. We also assist you with the application process.

### Service specifications

The purpose of the energy data input system check is to determine and show a measuring point and measuring technology concept as the basis for building up your energy monitoring system.

The following services are included:

- Selection and inspection of measuring points
- Stock-take of existing meters and their suitability as well as their retrofittability for data transmission
- Stock-take of existing data transmission channels
- Compilation of a measuring technology concept
- Preparation of a report on findings with advice on subsidies

C



## Our expertise for your requirements

### Service connects – worldwide



Automation technology functions are becoming more complex in a globally-oriented world facing ambitious targets in terms of energy efficiency and smart production. We are your equal partners for the best connections in Industrial Connectivity.

Our personal support can answer any questions reliably and expertly. Our online services are available 365 day a year around the clock to provide answers to your questions on our products - from user documentation through software to planning tools.

In short: Weidmüller's global service combines our expertise with your requirements.



**Your way to our service**  
[www.weidmueller.com/service](http://www.weidmueller.com/service)

## Engineering support and customised assembly

Automation engineering and connectivity consulting belongs to our services as well as assembly of engineered products. We also support the process from the idea to the product with our Weidmüller Configurator and the Configure-to-Order process.



### Consulting and engineering

The challenge for you is reducing costs and increasing efficiency. This requires intelligent, individual solutions. Whether it is modified products, pre-fitted mounting rails or complete small cabinets - our application centres provide a highly qualified custom-made engineering and production service.



### Connectivity Consulting

Alongside our product offering, we support you with our range of services through all the phases of machine construction. The result of this collaboration is a reduction of up to 30% in cycle times, up to 20% more space in the control cabinet and significant fault reduction. Our experienced Connectivity Consulting team delivers a practical impetus rather than just abstract theories.



### Fitted mounting rails

Your processes in panel building have to be fast, flexible and productive. This is the only way you can cut your costs and increase efficiency. Depending on the application in question, you will have different requirements with respect to the engineering service, delivery speed and flexibility to be provided.



### Processed and assembled enclosures

To compete internationally, your plants need to satisfy high standards of safety, quality and performance. The smart combination of consultation, application expertise and industry know-how is our key to finding a custom-fit solution for your application. Reduce costs and increase efficiency

## Personal support

Exactly the right help and information on our solutions and products

### C



If our products are used in your automation technology applications, you need the best possible individual support, from planning through installation to operation. For every stage of your application, we can offer the right tools and information for our products and solutions. Up-to-date, uncomplicated, comprehensive and around the clock via our service portal at [www.weidmueller.com/support](http://www.weidmueller.com/support).



**Your way to your local personal support**  
[www.weidmueller.com/support](http://www.weidmueller.com/support)



### Technical downloads

All information, such as technical data, manuals, certificates and much more for the appropriate use of our products and solutions in your application

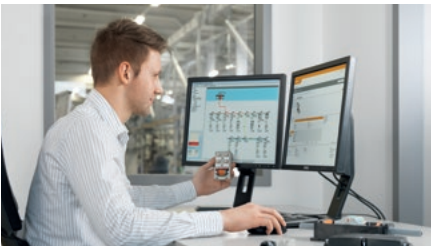

### Engineering data

For the quick integration of our products into your design, there are a lot of digital product data for engineering systems like EPLAN, Zuken E3.series, WSCAD and many others available for download.



### Product software

Our software makes using and configuration of our products easier for you when it comes to operation, configuration and monitoring



### Approvals, certificates & declaration of conformity

We supply product- or company-related approvals and certificates for your documentation



### Security advisory board

Our Product Security Incident Response Team (PSIRT) continuously informs you about possible security-related vulnerabilities of our products



# Index

<b>Index</b>	Index Type	X.2
	Index Order No.	X.3
	Addresses worldwide	X.6

Type	Order No.	Page
<b>B</b>		
BATTERY-CR1220-3V	2684410000	A.92
BATTERY-CR1220-3V	2684410000	A.93
BATTERY-CR1220-3V	2684410000	A.94

Type	Order No.	Page
<b>C</b>		
CMA-101-2500-5A-10VA-0.5	2680250000	A.50
CMA-101-2500-5A-10VA-1	2680190000	A.50
CMA-31-100-5A-2.5VA-1	1482030000	A.50
CMA-31-125-5A-2.5VA-0.5	2680200000	A.50
CMA-31-150-5A-2.5VA-0.5	2421030000	A.50
CMA-31-150-5A-5VA-1	2420960000	A.50
CMA-31-200-5A-2.5VA-0.5	2421020000	A.50
CMA-31-200-5A-5VA-1	2420950000	A.50
CMA-31-250-5A-5VA-0.5	1482050000	A.50
CMA-31-250-5A-5VA-1	2420940000	A.50
CMA-31-300-5A-5VA-0.5	2420990000	A.50
CMA-31-400-5A-5VA-0.5	2420980000	A.50
CMA-31-400-5A-5VA-1	2420920000	A.50
CMA-31-500-5A-5VA-0.5	1482070000	A.50
CMA-31-500-5A-5VA-1	2420910000	A.50
CMA-31-600-5A-5VA-0.5	2420970000	A.50
CMA-31-600-5A-5VA-1	2420900000	A.50
CMA-31-60-5A-1.25VA-1	2421380000	A.50
CMA-31-750-5A-5VA-0.5	1482080000	A.50
CMA-31-750-5A-5VA-1	2420890000	A.50
CMA-31-75-5A-2.5VA-1	1482040000	A.50
CMA-41-1000-5A-5VA-0.5	2680210000	A.50
CMA-41-1000-5A-5VA-1	2680150000	A.50
CMA-51-1250-5A-5VA-0.5	2680220000	A.50
CMA-51-1250-5A-5VA-1	2680160000	A.50
CMA-61-1500-5A-5VA-0.5	2680230000	A.50
CMA-61-1500-5A-5VA-1	2680170000	A.50
CMA-81-2000-5A-10VA-0.5	2680240000	A.50
CMA-81-2000-5A-10VA-1	2680180000	A.50
CMA-CTM-7-32-1A-0.2VA-1	2525150000	A.52
CMA-CTM-7-50-1A-0.4VA-1	2556030000	A.52
CMA-CTM-7-64-1A-0.5VA-1	2556010000	A.52
CMA-RCM-DACT-120	2603450000	A.60
CMA-RCM-DACT-20	2603420000	A.60
CMA-RCM-DACT-35	2603430000	A.60
CMA-RCM-DACT-60	2603440000	A.60

Type	Order No.	Page
<b>D</b>		
DEK 5/8-11.5 MC NE WS	1341630000	A.81
DEK 5/8-11.5 MC NE WS	1341630000	A.83
DEK 5/8-11.5 MC NE WS	1341630000	A.84
DEK 5/8-11.5 MC NE WS	1341630000	A.85
DEK 5/8-11.5 MC NE WS	1341630000	A.86
DEK 5/8-11.5 MC NE WS	1341630000	A.87
DEK 5/8-11.5 MC NE WS	1341630000	A.88
DEK 5/8-11.5 MC NE WS	1341630000	A.89
DEK 5/8-11.5 MC NE WS	1341630000	A.90
DEK 5/8-11.5 MC NE WS	1341630000	A.91
DEK 5/8-11.5 MC NE WS	1341630000	A.92
DEK 5/8-11.5 MC NE WS	1341630000	A.93
DEK 5/8-11.5 MC NE WS	1341630000	A.94
DEK 5/8-11.5 MC SDR	1341610000	A.81
DEK 5/8-11.5 MC SDR	1341610000	A.83
DEK 5/8-11.5 MC SDR	1341610000	A.84
DEK 5/8-11.5 MC SDR	1341610000	A.85
DEK 5/8-11.5 MC SDR	1341610000	A.86
DEK 5/8-11.5 MC SDR	1341610000	A.87
DEK 5/8-11.5 MC SDR	1341610000	A.88
DEK 5/8-11.5 MC SDR	1341610000	A.89
DEK 5/8-11.5 MC SDR	1341610000	A.90
DEK 5/8-11.5 MC SDR	1341610000	A.91
DEK 5/8-11.5 MC SDR	1341610000	A.92
DEK 5/8-11.5 MC SDR	1341610000	A.93
DEK 5/8-11.5 MC SDR	1341610000	A.94

Type	Order No.	Page
<b>E</b>		
EM-CONNECTIVITY-BOX 144	8000028952	A.72
EM-CONNECTIVITY-BOX 96	8000028950	A.72
EM-CONNECTIVITY-BOX TS	8000028951	A.72
ENERGY ANALYSER 550	2425500000	A.21
ENERGY ANALYSER 550	2425500000	A.35
ENERGY ANALYSER 550-24	2602580000	A.21
ENERGY ANALYSER 550-24	2602580000	A.35
ENERGY ANALYSER 750-230	2534130000	A.21
ENERGY ANALYSER 750-230	2534130000	A.36
ENERGY ANALYSER 750-24	2534160000	A.21
ENERGY ANALYSER 750-24	2534160000	A.36
ENERGY ANALYSER D550	2425510000	A.21
ENERGY ANALYSER D550	2425510000	A.34
ENERGY ANALYSER D550-24	2489780000	A.21
ENERGY ANALYSER D550-24	2489780000	A.34
ENERGY LOGGER D550	2425520000	A.21
ENERGY LOGGER D550	2425520000	A.39
ENERGY LOGGER SO MODULE	2446170000	A.39
ENERGY METER 520-230	2500880000	A.21
ENERGY METER 520-230	2500880000	A.25
ENERGY METER 520-24	2500880000	A.21
ENERGY METER 520-24	2500880000	A.25
ENERGY METER 525-230	2540890000	A.21
ENERGY METER 525-230	2540890000	A.26
ENERGY METER 525-24	2540880000	A.21
ENERGY METER 525-24	2540880000	A.26
ENERGY METER 610-230	2540850000	A.21
ENERGY METER 610-230	2540850000	A.27
ENERGY METER 610-24	2540920000	A.21

Type	Order No.	Page
<b>F</b>		
ENERGY METER 610-24	2540920000	A.27
ENERGY METER 610-PB-230	2540870000	A.21
ENERGY METER 610-PB-230	2540870000	A.28
ENERGY METER 610-PB-24	2540860000	A.21
ENERGY METER 610-PB-24	2540860000	A.28
ENERGY METER 700-PN-230	2500890000	A.21
ENERGY METER 700-PN-230	2500890000	A.29
ENERGY METER 700-PN-24	2500870000	A.21
ENERGY METER 700-PN-24	2500870000	A.29
ENERGY METER 750-230	2540910000	A.21
ENERGY METER 750-230	2540910000	A.30
ENERGY METER 750-24	2540900000	A.21
ENERGY METER 750-24	2540900000	A.30
ENERGY METER BRACKET B1	2433040000	A.35
ENERGY METER BRACKET B1	2433040000	A.36
ENERGY METER BRACKET L1	2433060000	A.26
ENERGY METER BRACKET L1	2433060000	A.27
ENERGY METER BRACKET L1	2433060000	A.28
ENERGY METER BRACKET L1	2433060000	A.29
ENERGY METER BRACKET L1	2433060000	A.30
ENERGY METER BRACKET S2	2433070000	A.25
ENERGY METER D370-CBM	2540830000	A.21
ENERGY METER D370-CBM	2540830000	A.24
ENERGY METER FIXING SET	2433030000	A.25
ENERGY METER FIXING SET	2433030000	A.26
ENERGY METER FIXING SET	2433030000	A.27
ENERGY METER FIXING SET	2433030000	A.28
ENERGY METER FIXING SET	2433030000	A.29
ENERGY METER FIXING SET	2433030000	A.30
ENERGY METER SEAL L144	2495630000	A.35
ENERGY METER SEAL L144	2495630000	A.36
ENERGY METER SEAL L96-2	2495610000	A.25
ENERGY METER SEAL L96-2	2495610000	A.26
ENERGY METER SEAL L96-2	2495610000	A.27
ENERGY METER SEAL L96-2	2495610000	A.28
ENERGY METER SEAL L96-2	2495610000	A.29
ENERGY METER SEAL L96-2	2495610000	A.30
ESD UR20 DIN A4 WS	1429430000	A.81
ESD UR20 DIN A4 WS	1429430000	A.83
ESD UR20 DIN A4 WS	1429430000	A.85
ESD UR20 DIN A4 WS	1429430000	A.86
ESD UR20 DIN A4 WS	1429430000	A.87
ESD UR20 DIN A4 WS	1429430000	A.88
ESD UR20 DIN A4 WS	1429430000	A.89
ESD UR20 DIN A4 WS	1429430000	A.90
ESD UR20 DIN A4 WS	1429430000	A.91
ESD UR20 DIN A4 WS	1429430000	A.92
ESD UR20 DIN A4 WS	1429430000	A.93
ESD UR20 DIN A4 WS	1429430000	A.94

Type	Order No.	Page
<b>I</b>		
IE-USB-A-MICRO-1.8M	1487980000	A.81
IE-USB-A-MICRO-1.8M	1487980000	A.92
IE-USB-A-MICRO-1.8M	1487980000	A.93
IE-USB-A-MICRO-1.8M	1487980000	A.94
IOT-GW30	2682620000	A.106
IT20-ATDIORO-NB-P	2740080000	A.46

Type	Order No.	Page
<b>K</b>		
KCMA 5-1000-5A-5VA-0.5	2753400000	A.58
KCMA 5-250-5A-1.5VA-1	2753360000	A.58
KCMA 5-400-5A-1VA-0.5	2753370000	A.58
KCMA 5-500-5A-2.5VA-0.5	2753380000	A.58
KCMA 5-600-5A-2.5VA-0.5	2753390000	A.58
KCMA-18-100-1A-0.3VA-1	2752990000	A.53
KCMA-18-100-1A-1.25VA-3	1482010000	A.53
KCMA-18-125-1A-0.5VA-1	2753000000	A.53
KCMA-18-125-1A-1.5VA-3	2752980000	A.53
KCMA-18-150-1A-1VA-1	2753010000	A.53
KCMA-18-150-1A-2VA-3	2420770000	A.53
KCMA-18-150-5A-1VA-1	2753030000	A.53
KCMA-18-200-1A-1.5VA-1	2753020000	A.53
KCMA-18-200-1A-3VA-3	2420760000	A.53
KCMA-18-200-5A-1.5VA-1	2753040000	A.53
KCMA-18-250-1A-1.5VA-1	1482000000	A.53
KCMA-18-250-1A-4VA-3	2420750000	A.53
KCMA-18-250-5A-1VA-0.5	2753050000	A.53
KCMA-18-50-1A-1VA-3	1482020000	A.53
KCMA-18-75-1A-1VA-3	2420780000	A.53
KCMA-28-200-1A-0.3VA-1	2753060000	A.54
KCMA-28-250-1A-1VA-1	2753070000	A.54
KCMA-28-250-5A-1VA-1	2753110000	A.54
KCMA-28-300-1A-1.5VA-1	2753080000	A.54
KCMA-28-300-5A-1.5VA-1	2753120000	A.54
KCMA-28-400-1A-2.5VA-1	2753090000	A.54
KCMA-28-400-5A-2.5VA-1	2753130000	A.54
KCMA-28-500-1A-1VA-0.5	2753100000	A.54
KCMA-28-500-5A-3VA-1	2753140000	A.54
KCMA-32-400-1A-5VA-1	1481990000	A.55
KCMA-32-400-5A-5VA-1	2420730000	A.55
KCMA-32-500-5A-5VA-1	2420740000	A.55
KCMA-32-600-1A-5VA-1	1481980000	A.55
KCMA-32-600-5A-5VA-1	2420720000	A.55
KCMA-42-1000-1A-2.5VA-0.5	2753220000	A.56
KCMA-42-1000-5A-2.5VA-0.5	2753290000	A.56
KCMA-42-250-1A-2.5VA-1	2753150000	A.56
KCMA-42-300-1A-2.5VA-1	2753160000	A.56
KCMA-42-300-5A-2.5VA-1	2753230000	A.56
KCMA-42-400-1A-2.5VA-0.5	2753170000	A.56
KCMA-42-400-5A-5VA-1	2753240000	A.56

Type	Order No.	Page
<b>L</b>		
KCMA-42-500-1A-2.5VA-0.5	2753180000	A.56
KCMA-42-500-5A-5VA-1	2753250000	A.56
KCMA-42-600-1A-2.5VA-0.5	2753190000	A.56
KCMA-42-600-5A-2.5VA-0.5	2753260000	A.56
KCMA-42-750-1A-2.5VA-0.5	2753200000	A.56
KCMA-42-750-5A-2.5VA-0.5	2753270000	A.56
KCMA-42-800-1A-2.5VA-0.5	2753210000	A.56
KCMA-42-800-5A-2.5VA-0.5	2753280000	A.56
KCMA-44-1000-5A-5VA-1	2437400000	A.57
KCMA-44-750-5A-5VA-1	2420710000	A.57
KCMA-44-800-5A-5VA-1	2437370000	A.57
KCMA-8-1000-5A-10VA1	2728130000	A.59
KCMA-8-1000-5A-5VA-0.5	2753430000	A.59
KCMA-8-1200-5A-10VA1	2728140000	A.59
KCMA-8-1200-5A-5VA-0.5	2753450000	A.59
KCMA-8-1500-5A-5VA-1	2728150000	A.59
KCMA-8-2000-5A-15VA1	2728160000	A.59
KCMA-8-2500-5A-15VA1	2728170000	A.59
KCMA-8-250-5A-1.5VA1	2728090000	A.59
KCMA-8-3000-5A-15VA1	2728180000	A.59
KCMA-8-4000-5A-15VA1	2728190000	A.59
KCMA-8-5000-5A-15VA1	2728210000	A.59
KCMA-8-500-5A-5VA1	2728100000	A.59
KCMA-8-600-5A-2.5VA-0.5	2753410000	A.59
KCMA-8-750-5A-2VA1	2728110000	A.59
KCMA-8-800-5A-2.5VA-0.5	2753420000	A.59
KCMA-RCM-23D	2656270000	A.62
KCMA-RCM-58D	2656280000	A.62
KCMA-RCM-812D	2656290000	A.62
KOSM BH25.00	1483050000	A.81
K		

Order No.	Type	Page
-----------	------	------

## 1310000000

1315170000	UR20-4DI-P	A.84
1315180000	UR20-8DI-P-2W	A.85
1315590000	UR20-2CNT-100	A.88
1315700000	UR20-4AIRTD-DIAG	A.87

## 1320000000

1323700000	PM 2.7/2.6 MC SDR	A.81
1323700000	PM 2.7/2.6 MC SDR	A.83
1323700000	PM 2.7/2.6 MC SDR	A.84
1323700000	PM 2.7/2.6 MC SDR	A.85
1323700000	PM 2.7/2.6 MC SDR	A.86
1323700000	PM 2.7/2.6 MC SDR	A.87
1323700000	PM 2.7/2.6 MC SDR	A.88
1323700000	PM 2.7/2.6 MC SDR	A.92
1323700000	PM 2.7/2.6 MC SDR	A.93
1323700000	PM 2.7/2.6 MC SDR	A.94
1323710000	PM 2.7/2.6 MC NE WS	A.81
1323710000	PM 2.7/2.6 MC NE WS	A.83
1323710000	PM 2.7/2.6 MC NE WS	A.84
1323710000	PM 2.7/2.6 MC NE WS	A.85
1323710000	PM 2.7/2.6 MC NE WS	A.86
1323710000	PM 2.7/2.6 MC NE WS	A.87
1323710000	PM 2.7/2.6 MC NE WS	A.88
1323710000	PM 2.7/2.6 MC NE WS	A.92
1323710000	PM 2.7/2.6 MC NE WS	A.93
1323710000	PM 2.7/2.6 MC NE WS	A.94

## 1330000000

1334950000	UC20-WL2000-AC	A.93
1334990000	UC20-WL2000HOT	A.94
1339920000	UR20-SM-ACC	A.81
1339920000	UR20-SM-ACC	A.83
1339920000	UR20-SM-ACC	A.84
1339920000	UR20-SM-ACC	A.85
1339920000	UR20-SM-ACC	A.86
1339920000	UR20-SM-ACC	A.87
1339920000	UR20-SM-ACC	A.88
1339920000	UR20-SM-ACC	A.92
1339920000	UR20-SM-ACC	A.93
1339920000	UR20-SM-ACC	A.94

## 1340000000

1341610000	DEK 5/8-11.5 MC SDR	A.81
1341610000	DEK 5/8-11.5 MC SDR	A.83
1341610000	DEK 5/8-11.5 MC SDR	A.84
1341610000	DEK 5/8-11.5 MC SDR	A.85
1341610000	DEK 5/8-11.5 MC SDR	A.86
1341610000	DEK 5/8-11.5 MC SDR	A.87
1341610000	DEK 5/8-11.5 MC SDR	A.88
1341610000	DEK 5/8-11.5 MC SDR	A.92
1341610000	DEK 5/8-11.5 MC SDR	A.93
1341610000	DEK 5/8-11.5 MC SDR	A.94
1341630000	DEK 5/8-11.5 MC NE WS	A.81
1341630000	DEK 5/8-11.5 MC NE WS	A.83
1341630000	DEK 5/8-11.5 MC NE WS	A.84
1341630000	DEK 5/8-11.5 MC NE WS	A.85
1341630000	DEK 5/8-11.5 MC NE WS	A.86
1341630000	DEK 5/8-11.5 MC NE WS	A.87
1341630000	DEK 5/8-11.5 MC NE WS	A.88
1341630000	DEK 5/8-11.5 MC NE WS	A.92
1341630000	DEK 5/8-11.5 MC NE WS	A.93
1341630000	DEK 5/8-11.5 MC NE WS	A.94
1346430000	UR20-PK-1315180000-SP	A.85
1346440000	UR20-PK-1315170000-SP	A.84
1346540000	UR20-PK-1315590000-SP	A.88
1346610000	UR20-EBK-ACC	A.81
1346610000	UR20-EBK-ACC	A.83
1346610000	UR20-EBK-ACC	A.84
1346610000	UR20-EBK-ACC	A.85
1346610000	UR20-EBK-ACC	A.86
1346610000	UR20-EBK-ACC	A.87
1346610000	UR20-EBK-ACC	A.88
1346610000	UR20-EBK-ACC	A.92
1346610000	UR20-EBK-ACC	A.93
1346610000	UR20-EBK-ACC	A.94
1346640000	UR20-EM-1315170000-SP	A.84
1347150000	UR20-EM-1315590000-SP	A.88
1347290000	UR20-EM-1315700000-SP	A.87

## 1350000000

1350930000	UR20-BM-SP	A.83
1350930000	UR20-BM-SP	A.84
1350930000	UR20-BM-SP	A.85
1350930000	UR20-BM-SP	A.86
1350930000	UR20-BM-SP	A.87
1350930000	UR20-BM-SP	A.88

## 1390000000

1394390000	UR20-4AIU-F12	A.86
------------	---------------	------

Order No.	Type	Page
-----------	------	------

## 1420000000

1423550000	POWER MONITOR	A.31
1429420000	THM UR20 WS	A.81
1429420000	THM UR20 WS	A.83
1429420000	THM UR20 WS	A.85
1429420000	THM UR20 WS	A.86
1429420000	THM UR20 WS	A.87
1429420000	THM UR20 WS	A.88
1429420000	THM UR20 WS	A.89
1429420000	THM UR20 WS	A.92
1429420000	THM UR20 WS	A.93
1429420000	THM UR20 WS	A.94
1429430000	ESO UR20 DIN A4 WS	A.81
1429430000	ESO UR20 DIN A4 WS	A.83
1429430000	ESO UR20 DIN A4 WS	A.85
1429430000	ESO UR20 DIN A4 WS	A.86
1429430000	ESO UR20 DIN A4 WS	A.87
1429430000	ESO UR20 DIN A4 WS	A.88
1429430000	ESO UR20 DIN A4 WS	A.92
1429430000	ESO UR20 DIN A4 WS	A.93
1429430000	ESO UR20 DIN A4 WS	A.94
1429910000	THM UR20 GE	A.81
1429910000	THM UR20 GE	A.83
1429910000	THM UR20 GE	A.85
1429910000	THM UR20 GE	A.86
1429910000	THM UR20 GE	A.87
1429910000	THM UR20 GE	A.88
1429910000	THM UR20 GE	A.92
1429910000	THM UR20 GE	A.93
1429910000	THM UR20 GE	A.94

## 1430000000

1434230000	UR20-EM-1394390000-SP	A.86
------------	-----------------------	------

## 1470000000

1470260000	POWER MONITOR 51A	A.31
------------	-------------------	------

## 1480000000

1481980000	KCMA-32-600-1A-5VA-1	A.55
1481990000	KCMA-32-400-1A-5VA-1	A.55
1482000000	KCMA-18-250-1A-1.5VA-1	A.53
1482010000	KCMA-18-100-1A-1.25VA-3	A.53
1482020000	KCMA-18-50-1A-1VA-3	A.53
1482030000	CMA-31-100-5A-2.5VA-1	A.50
1482040000	CMA-31-75-5A-2.5VA-1	A.50
1482050000	CMA-31-250-5A-5VA-0.5	A.50
1482070000	CMA-31-500-5A-5VA-0.5	A.50
1482080000	CMA-31-750-5A-5VA-0.5	A.50
1483050000	KOSM BH25.00	A.81
1483050000	KOSM BH25.00	A.83
1483050000	KOSM BH25.00	A.85
1483050000	KOSM BH25.00	A.86
1483050000	KOSM BH25.00	A.87
1483050000	KOSM BH25.00	A.88
1483050000	KOSM BH25.00	A.92
1483050000	KOSM BH25.00	A.93
1483050000	KOSM BH25.00	A.94
1484030000	UR20-PK-1394390000-SP	A.86
1484040000	UR20-PK-1315700000-SP	A.87
1487980000	IE-USB-A-MICRO-1.8M	A.81
1487980000	IE-USB-A-MICRO-1.8M	A.92
1487980000	IE-USB-A-MICRO-1.8M	A.93
1487980000	IE-USB-A-MICRO-1.8M	A.94

## 1490000000

1490220000	UR20-EM-1315180000-SP	A.85
------------	-----------------------	------

## 1560000000

1562270000	UR20-EM-2007420000-SP	A.83
------------	-----------------------	------

## 2000000000

2007420000	UR20-3EM-230V-AC	A.83
------------	------------------	------

## 2060000000

2068630000	UR20-PK-2007420000-SP	A.83
------------	-----------------------	------

## 2090000000

2091060000	POWER MONITOR BRACKET	A.31
------------	-----------------------	------

## 2420000000

2420710000	KCMA-44-750-5A-5VA-1	A.57
2420720000	KCMA-32-600-5A-5VA-1	A.55
2420730000	KCMA-32-400-5A-5VA-1	A.55
2420740000	KCMA-32-500-5A-5VA-1	A.55
2420750000	KCMA-18-250-1A-4VA-3	A.53
2420760000	KCMA-18-200-1A-3VA-3	A.53
2420770000	KCMA-18-150-1A-2VA-3	A.53
2420780000	KCMA-18-75-1A-1VA-3	A.53
2420890000	CMA-31-750-5A-5VA-1	A.50
2420900000	CMA-31-600-5A-5VA-1	A.50

Order No.	Type	Page
-----------	------	------

2420910000	CMA-31-500-5A-5VA-1	A.50
2420920000	CMA-31-400-5A-5VA-1	A.50
2420940000	CMA-31-250-5A-5VA-1	A.50
2420950000	CMA-31-200-5A-5VA-1	A.50
2420960000	CMA-31-150-5A-5VA-1	A.50
2420970000	CMA-31-600-5A-5VA-0.5	A.50
2420980000	CMA-31-400-5A-5VA-0.5	A.50
2420990000	CMA-31-300-5A-5VA-0.5	A.50
2421020000	CMA-31-200-5A-2.5VA-0.5	A.50
2421030000	CMA-31-150-5A-2.5VA-0.5	A.50
2421380000	CMA-31-60-5A-1.25VA-1	A.50
2425500000	ENERGY ANALYSER 550	A.21
2425500000	ENERGY ANALYSER 550	A.35
2425510000	ENERGY ANALYSER D550	A.21
2425510000	ENERGY ANALYSER D550	A.34
2425520000	ENERGY LOGGER D550	A.21
2425520000	ENERGY LOGGER D550	A.39

## 2430000000

2433030000	ENERGY METER FIXING SET	A.25
2433030000	ENERGY METER FIXING SET	A.26
2433030000	ENERGY METER FIXING SET	A.27
2433030000	ENERGY METER FIXING SET	A.28
2433030000	ENERGY METER FIXING SET	A.29
2433030000	ENERGY METER FIXING SET	A.30
2433040000	ENERGY METER BRACKET B1	A.35
2433040000	ENERGY METER BRACKET B1	A.36
2433060000	ENERGY METER BRACKET L1	A.26
2433060000	ENERGY METER BRACKET L1	A.27
2433060000	ENERGY METER BRACKET L1	A.28
2433060000	ENERGY METER BRACKET L1	A.29
2433060000	ENERGY METER BRACKET L1	A.30
2433070000	ENERGY METER BRACKET S2	A.25
2437370000	KCMA-44-800-5A-5VA-1	A.57
2437400000	KCMA-44-1000-5A-5VA-1	A.57

## 2440000000

2446170000	ENERGY LOGGER SD MODULE	A.39
------------	-------------------------	------

## 2470000000

2476450000	UR20-FBC-MOD-TCP-V2	A.81
------------	---------------------	------

## 2480000000

2485280000	UR20-PK-2476450000-SP	A.81
2489780000	ENERGY ANALYSER D550-24	A.21
2489780000	ENERGY ANALYSER D550-24	A.34

## 2490000000

2495610000	ENERGY METER SEAL L96-2	A.25
2495610000	ENERGY METER SEAL L96-2	A.26
2495610000	ENERGY METER SEAL L96-2	A.27
2495610000	ENERGY METER SEAL L96-2	A.28
2495610000	ENERGY METER SEAL L96-2	A.29
2495610000	ENERGY METER SEAL L96-2	A.30
2495630000	ENERGY METER SEAL L144	A.35
2495630000	ENERGY METER SEAL L144	A.36

## 2500000000

2500860000	ENERGY METER 520-24	A.21
2500860000	ENERGY METER 520-24	A.25
2500870000	ENERGY METER 700-PN-24	A.21
2500870000	ENERGY METER 700-PN-24	A.29
2500880000	ENERGY METER 520-230	A.21
2500880000	ENERGY METER 520-230	

Order No.	Type	Page
-----------	------	------

## 2740000000

2740080000	IT20-ATDIORO-NB-P	A.46
------------	-------------------	------

## 2750000000

2752980000	KCMA-18-125-1A-1,5VA-3	A.53
2752990000	KCMA-18-100-1A-0.3VA-1	A.53
2753000000	KCMA-18-125-1A-0.5VA-1	A.53
2753010000	KCMA-18-150-1A-1VA-1	A.53
2753020000	KCMA-18-200-1A-1,5VA-1	A.53
2753030000	KCMA-18-150-5A-1VA-1	A.53
2753040000	KCMA-18-200-5A-1,5VA-1	A.53
2753050000	KCMA-18-250-5A-1VA-0.5	A.53
2753060000	KCMA-28-200-1A-0.3VA-1	A.54
2753070000	KCMA-28-250-1A-1VA-1	A.54
2753080000	KCMA-28-300-1A-1,5VA-1	A.54
2753090000	KCMA-28-400-1A-2,5VA-1	A.54
2753100000	KCMA-28-500-1A-1VA-0.5	A.54
2753110000	KCMA-28-250-5A-1VA-1	A.54
2753120000	KCMA-28-300-5A-1,5VA-1	A.54
2753130000	KCMA-28-400-5A-2,5VA-1	A.54
2753140000	KCMA-28-500-5A-3VA-1	A.54
2753150000	KCMA-42-250-1A-2,5VA-1	A.56
2753160000	KCMA-42-300-1A-2,5VA-1	A.56
2753170000	KCMA-42-400-1A-2,5VA-0.5	A.56
2753180000	KCMA-42-500-1A-2,5VA-0.5	A.56
2753190000	KCMA-42-600-1A-2,5VA-0.5	A.56
2753200000	KCMA-42-750-1A-2,5VA-0.5	A.56
2753210000	KCMA-42-800-1A-2,5VA-0.5	A.56
2753220000	KCMA-42-1000-1A-2,5VA-0.5	A.56
2753230000	KCMA-42-300-5A-2,5VA-1	A.56
2753240000	KCMA-42-400-5A-5VA-1	A.56
2753250000	KCMA-42-500-5A-5VA-1	A.56
2753260000	KCMA-42-600-5A-2,5VA-0.5	A.56
2753270000	KCMA-42-750-5A-2,5VA-0.5	A.56
2753280000	KCMA-42-800-5A-2,5VA-0.5	A.56
2753290000	KCMA-42-1000-5A-2,5VA-0.5	A.56
2753360000	KCMA 5-250-5A-1.5VA-1	A.58
2753370000	KCMA 5-400-5A-1VA-0.5	A.58
2753380000	KCMA 5-500-5A-2,5VA-0.5	A.58
2753390000	KCMA 5-600-5A-2,5VA-0.5	A.58
2753400000	KCMA 5-1000-5A-5VA-0.5	A.58
2753410000	KCMA-8-600-5A-2,5VA-0.5	A.59
2753420000	KCMA-8-800-5A-2,5VA-0.5	A.59
2753430000	KCMA-8-1000-5A-5VA-0.5	A.59
2753450000	KCMA-8-1200-5A-5VA-0.5	A.59

## 8000000000

8000028895	LST EM-BLOCK	A.66
8000028950	EM-CONNECTIVITY-BOX 96	A.72
8000028951	EM-CONNECTIVITY-BOX TS	A.72
8000028952	EM-CONNECTIVITY-BOX 144	A.72
8000061153	LST CT-Block	A.66



# Addresses worldwide

Let's connect.

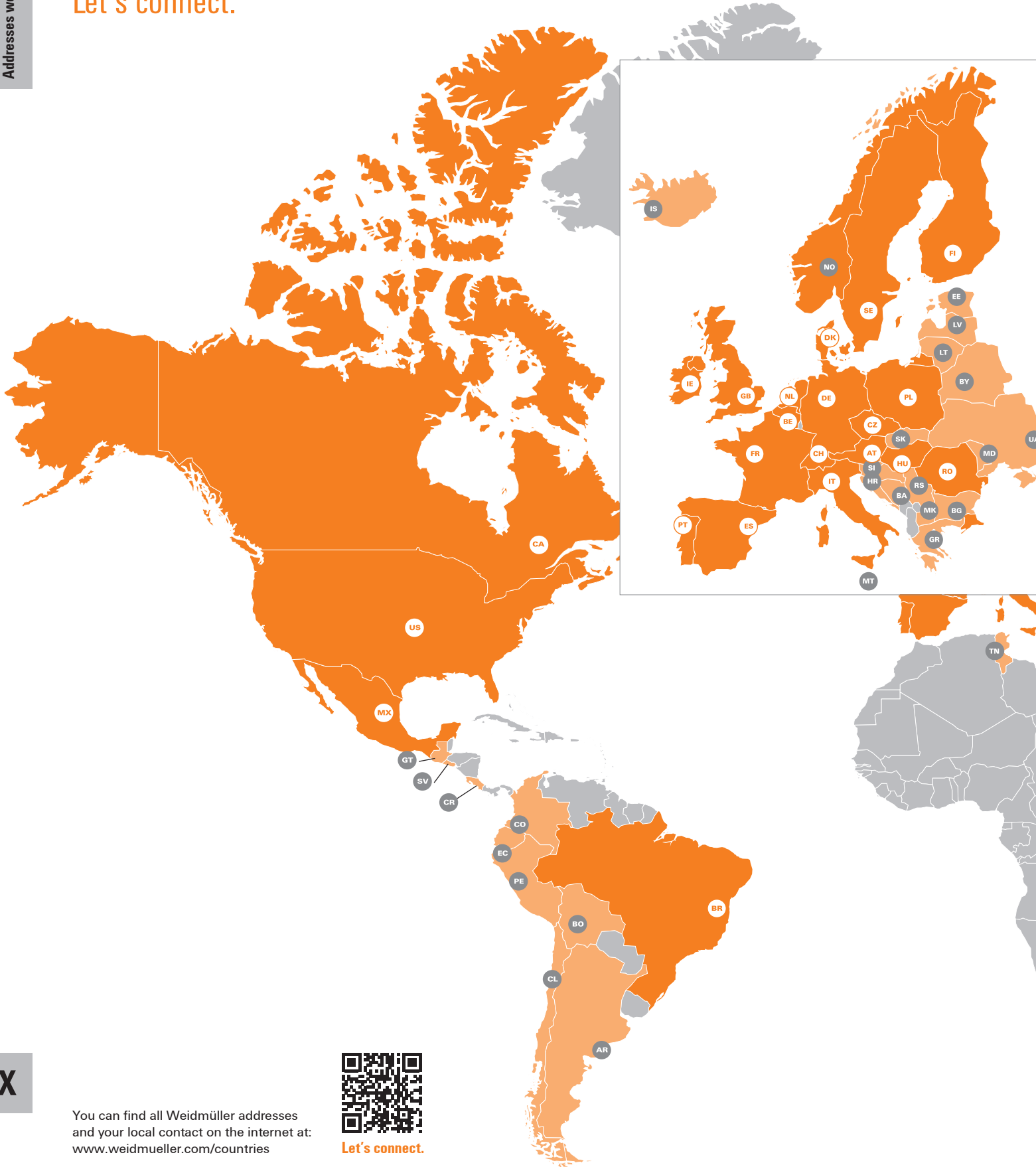

X

You can find all Weidmüller addresses and your local contact on the internet at: [www.weidmueller.com/countries](http://www.weidmueller.com/countries)



Let's connect.

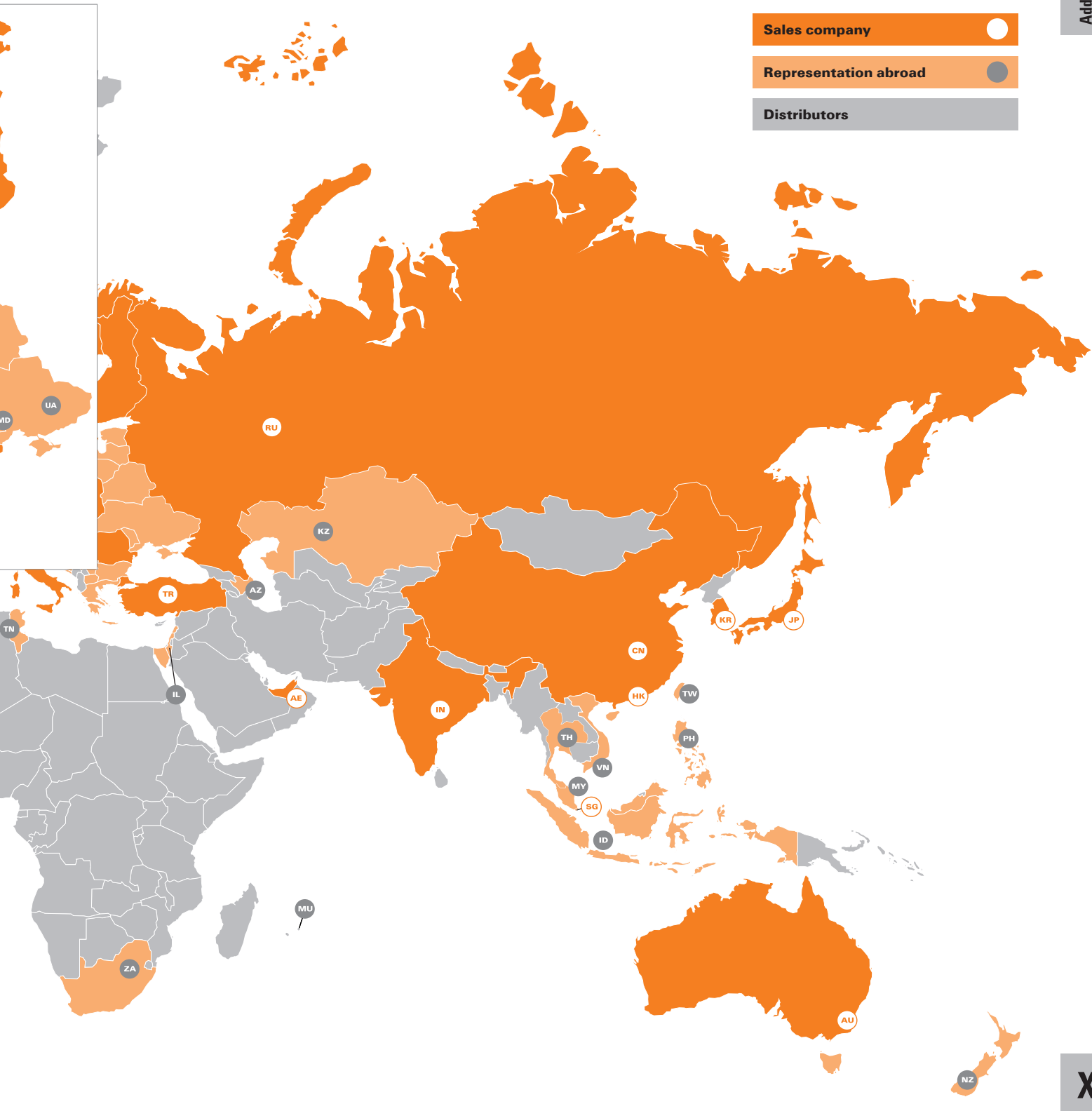

We cannot guarantee that there are no mistakes in the publications or software provided by us to the customer for the purpose of making orders. We try our best to quickly correct errors in our printed media.

**X**

All orders are based on our general terms of delivery, which can be reviewed on the websites of our group companies where you place your order. On demand we can also send the general terms of delivery to you.



## Weidmüller – Your partner in Industrial Connectivity

As experienced experts we support our customers and partners around the world with products, solutions and services in the industrial environment of power, signal and data. We are at home in their industries and markets and know the technological challenges of tomorrow. We are therefore continuously developing innovative, sustainable and useful solutions for their individual needs. Together we set standards in Industrial Connectivity.

### Technical Guide

More detailed information on our measuring and monitoring systems is available on our website. In addition we offer a Technical Guide with comprehensive technical basic knowledge related to the subject of energy monitoring.

[www.weidmueller.com/energymonitoring](http://www.weidmueller.com/energymonitoring)

Weidmüller Interface GmbH & Co. KG  
Klingenbergstraße 26  
32758 Detmold, Germany  
T +49 5231 14-0  
F +49 5231 14-292083  
[www.weidmueller.de](http://www.weidmueller.de)

Personal support can  
be found on our website:  
[www.weidmueller.com/contact](http://www.weidmueller.com/contact)

Made in Germany



Order number: 2751640000/12/2020/SMM